

# **IRS35(E)**

**All-in-one485Bus type open (closed) loop stepper driver**

**User ManualV1.0.0**

Shenzhen Gerui IoT Technology Co., Ltd.

Table of contents

1. Product Introduction.....	- 1 -
1.1 Product Overview.....	- 1 -
1.2 Product Features.....	- 1 -
1.3 Application areas.....	- 1 -
1.4 Naming convention.....	- 2 -
2. Mechanical, electrical and environmental indicators.....	- 3 -
2.1 Mechanical Installation Drawing.....	- 3 -
2.2 Installation Notes.....	- 3 -
2.3 Electrical Specifications.....	- 3 -
2.4 Operating environment and parameters.....	- 4 -
3. Driver interface and wiring description.....	- 4 -
3.1 Product interface overview.....	- 4 -
3.2 Indicator Lights.....	- 5 -
3.3 RS485 Communication interface.....	- 5 -
3.4 Input signal interface.....	- 6 -
3.4.1 Input signal description and wiring diagram.....	- 6 -
3.4.2 Input signal interface function.....	- 8 -
3.4.3 Input Signal Interface Function Description.....	- 9 -
3.5 Power Input Interface.....	- 9 -
Four, MODBUS Communication Protocol and Functions.....	- 10 -
4.1 Basic communication parameters.....	- 10 -
4.2 MODBUS Register Address Definition.....	- 11 -
4.2.1 Status Parameter Group (Read Only).....	- 11 -
4.2.2 Common parameter group1 (Read and Write).....	- 14 -
4.2.3 Common parameter groups in open loop mode (read and write).....	- 16 -
4.2.4 Common parameter groups in closed loop mode (read and write).....	- 17 -
4.2.5 Driver basic control parameter group1 (Read and Write).....	- 19 -
4.2.6 Return to origin parameter group (read and write).....	- twenty one -
4.2.7 Driver basic control parameter group2 (Read and Write).....	- twenty two -
4.2.8 Common parameter group2 (Read and Write).....	- twenty three -
4.2.9 Input function parameter group (read and write).....	- twenty four -
4.2.10 Multi-segment mode parameter group (read and write).....	- 26 -
4.2.11 Performance Parameter Group (Read and Write).....	- 30 -
4.2.12 Brake control parameter group (read and write).....	- 34 -
4.2.13 Status, fault code parameter group (read only).....	- 35 -
4.2.14 User Parameter Group (Read and Write).....	- 38 -
4.3 MODBUS Common function codes.....	- 39 -
4.3.1 Read Holding Register Command 0x03.....	- 39 -
4.3.2 Write Single Register Command 0x06.....	- 39 -
4.3.3 Write multiple registers command 0x10.....	- 40 -
4.4 Communication Error Codes.....	- 40 -
4.4.1 CRC Calibration Error.....	- 40 -
4.4.2 Function code sending error.....	- 41 -

4.4.3	Error in reading illegal data address.....	-41 -
4.4.4	The write data address exceeds the address range.....	41 -
4.4.5	Read register count overflow.....	-42 -
4.4.6	Function code illegal read and write data error.....	-42 -
4.4.7	Data written into register exceeds limit.....	-42 -
4.5	Application Examples.....	-43 -
4.5.1	Position Mode Operation Setting Example.....	-43 -
4.5.2	Speed Mode Operation Setup Example.....	-44 -
5.	Introduction to Motion Control Function.....	-46 -
5.1	Position Mode.....	-46 -
5.2	Speed Mode.....	-47 -
5.3	Return to origin mode.....	-48 -
5.3.1	Way(-3)(Stalled return to zero1).....	-48 -
5.3.2	Way(-4)(Stalled return to zero2).....	-49 -
5.3.3	Way(-5)(Stalled return to zero3).....	-49 -
5.3.4	Way(-6)(Stalled return to zero4).....	-49 -
5.3.5	Way17(Negative limit return to zero).....	-50 -
5.3.6	Way18(Positive limit return to zero).....	-50 -
5.3.7	Way19(Return to zero1).....	-50 -
5.3.8	Way20(Return to zero2).....	-51 -
5.3.9	Waytwenty one(Return to zero3).....	-51 -
5.3.10	Waytwenty two(Return to zero4).....	-52 -
5.3.11	Waytwenty three(Origin + positive limit return to zero1).....	-52 -
5.3.12	Waytwenty four(Origin + positive limit return to zero2).....	-53 -
5.3.13	Way25(Origin + positive limit return to zero3).....	-53 -
5.3.14	Way26(Origin + positive limit return to zero4).....	-54 -
5.3.15	Way27(Origin + negative limit return to zero1).....	-55 -
5.3.16	Way28(Origin + negative limit return to zero2).....	-55 -
5.3.17	Way29(Origin + negative limit return to zero3).....	-56 -
5.3.18	Way30(Origin + negative limit return to zero4).....	-56 -
5.3.19	Way33(ZSignal return to zero1).....	-57 -
5.3.20	Way34(ZSignal return to zero2).....	-57 -
5.3.21	Way35,37(Current position is the origin).....	-58 -
5.3.22	Way38(Position return mode1).....	-58 -
5.3.23	Way39(Position return mode2).....	-58 -
5.4	Multi-segment mode.....	-59 -
5.4.1	Multi-position mode.....	-59 -
5.4.1.1	IOTrigger + PathIOmodel.....	-59 -
5.4.1.2	IOTriggering Single Cycle Mode.....	-61 -
5.4.1.3	IOTriggering Continuous Loop Mode.....	-61 -
5.4.2	Multi-speed mode.....	-62 -
5.5	Motion Control Instructions.....	-64 -
5.5.1	Startup Command.....	64 -
5.5.2	Stop Command.....	64 -

---



---

VI. Indicator Lights.....	-65 -
6.1 Alarm fault code.....	-65 -
6.2 Flashing lights.....	-67 -
VII. Parameters and selection of suitable motors.....	-68 -
7.1 Motor Appearance Schematic.....	-68 -
7.2 Motor technical parameters.....	-68 -
7.3 Motor shaft parameters.....	-68 -
7.4 Wiring Definition.....	-69 -
8. Warranty and After-Sales Service.....	-70 -
8.1 Warranty.....	-70 -
8.1.1 Free warranty.....	-70 -
8.1.2 Warranty exclusions.....	-70 -
8.2 Exchange.....	-70 -
8.2.1 Product Failure Replacement.....	-70 -
8.2.2 Replacement for non-product failure.....	-71 -
8.3 return the goods.....	-71 -
8.4 After-sales service.....	-71 -
IX. Version Revision History.....	-72 -

## 1. Product Introduction

### 1.1 Product Overview

IRS35(E) All-in-one 485 Bus type open (closed) loop stepper driver is the latest product launched by Shenzhen Ge Rui IoT Technology Co., Ltd. It is a 485 Pass Digital hybrid step servo driver with communication function, integrated MODBUS-RTU standard protocol specifications, power supply interface, IO input and output ports. And the communication interface adopts ST1.25-12P. The user can set the subdivision, current, speed, working mode and other functions through the host computer debugging software. Parameters greatly enrich the practical functions of the product and can meet the application needs of most occasions.

IRS35(E) All-in-one 485 Bus type open (closed) loop stepper driver adopts a servo-like control principle and is compatible with open-loop stepper and servo systems. Double advantages, using the latest 32-bit DSP control technology has greatly improved the performance of the stepping system. It has excellent stability and ultra-low noise, high-speed torque is also greatly improved, expanding the speed application range of stepper motors. Smooth and precise pure sine current vector control. The control technology effectively reduces the heating of the motor, and it has strong compatibility and high cost performance, which can meet the application of most occasions.

### 1.2 Product Features

- New Generation 32-bit DSP Technology, good stability, strong compatibility, high cost performance
- Support open/closed loop mode switching
- Support speed mode, position mode, multi-segment position/speed mode, JOG+, JOG- And return to origin mode
- Current, lock current, subdivision, PI Parameters such as these can be set and queried through the master station
- Use RS485 Bus, with isolation, supports standard MODBUS-RTU protocol
- The default mailing address is 1, more can be set through the main station
- 34 opto-isolated programmable input interfaces receive external control signals to implement driver enable, start/stop, limit and other functions
- 10 opto-isolated programmable output interface, can be changed if needed
- Built-in micro-segmentation, excellent low-speed stability
- With overvoltage, undervoltage, phase loss, out-of-tolerance (closed loop has this alarm) and other alarm protection functions
- Pure sinusoidal current vector control effectively reduces motor heating
- DC power supply, input voltage range: DC12V~40V

### 1.3 Application Areas

Suitable for various small and medium-sized automation equipment and instruments, such as medical equipment, testing equipment, marking machines, plotters, etc. Noise, low heat, convenient wiring, stronger anti-interference and other requirements.

### 1.4 Naming convention

The driver model naming rules are as follows:

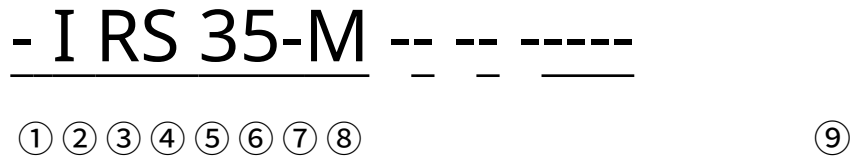

Serial number	meaning	
①	2Mutually/3phase distinction;	null:2Phase drive;
②	A general term for a product series;	I: Integrated drive;
③	Product series number;	RS:RS485drive;
④	Matching motor base;	35: Main match35Motor of the base;
⑤	The integrated bus series is divided into open and closed loops;	E: Closed-loop drive; Empty: Open-loop drive;
⑥	Whether it has a motor;	M: With motor integrated;
⑦	Motor body length;	
⑧	Special function code;	
⑨	Design change code;	

**2. Mechanical, electrical and environmental indicators**

**2.1 Mechanical installation drawing**

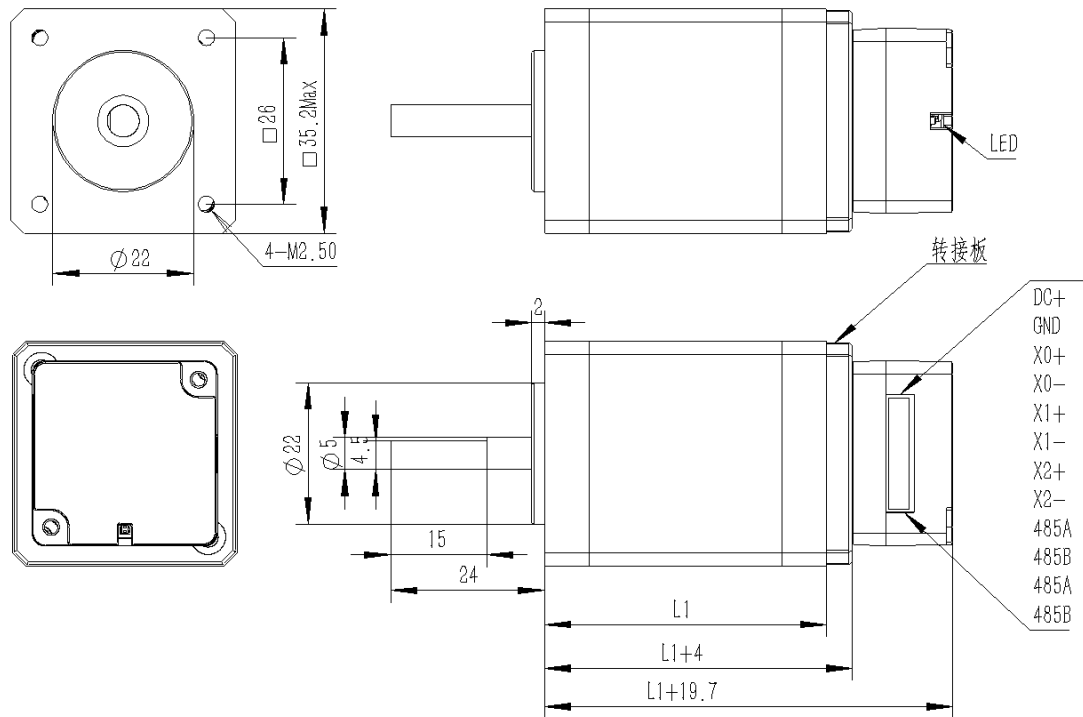

picture1 Installation Dimensions (Unit:mm)

**2.2 Installation Notes**

1) When installing the integrated stepper driver, do not knock on the rear cover of the motor to avoid affecting the running performance. When designing the installation dimensions, consider the wiring

Terminal size and wiring.

2) In order to ensure good heat dissipation conditions, a larger installation interval must be reserved as much as possible during actual installation. If multiple integrated drives are installed side by side,

A fan can be installed to form a strong air convection on the surface of the integrated driver to assist the driver in heat dissipation and ensure that the driver is at a reliable working temperature.

Work within the scope.

**2.3 Electrical specifications**

illustrate	IRS35(E)All-in-one485Bus type open (closed) loop stepper driver			
	Minimum	Typical Value	Maximum	unit
Output Current	0	-	2600	mA
Input power voltage	12	twenty four	40	VDC
Control signal input current	7	10	16	mA
Insulation resistance	50	-	-	MΩ

2.4 Use environment and parameters

Cooling method		Natural cooling, fan cooling
Usage Environment	occasion	Do not place it near other heating equipment. Avoid dust, oil mist, corrosive gas, high humidity and strong vibration. Do not place it near flammable gas and conductive dust.
	temperature	- 25°C~55°C
	humidity	40~90%RH
	vibration	10~55Hz/0.15mm
Storage temperature		- 25°C~65°C

3. Driver interface and wiring description

3.1 Product interface general description

IRS35(E)All-in-one485Power supply interface of bus type open (closed) loop stepper driver,IOInput and output ports and communication interfaces adopt

JST1.25-12Pstraight pin socket, as shown below3.1shown

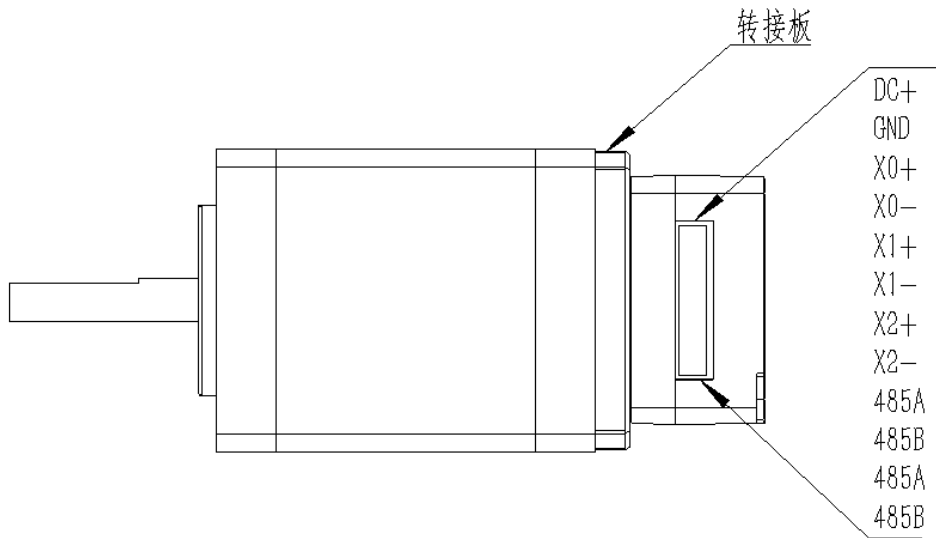

picture3.1 IRS35(E)Interface Diagram

The function description of each pin is as follows3.1shown.

surface3.1General description of interface functions

name	illustrate
GND	Negative pole of power supply
DC+	Positive pole of power supply, range:DC12~40V
X0+ X0-	DC 5V~24VPower supply, connect external input signal, support differential input
X1+ X1-	DC 5V~24VPower supply, connect external input signal, support differential input
X2+ X2-	DC 5V~24VPower supply, connect external input signal, support differential input
485A 485B	485Communication interfaceABend
485A 485B	Connect to the next drive485Communication interfaceABend



### 3.2 Indicator Lights

IRS35(E) All-in-one 485 The indicator light of the bus type open (closed) loop stepper driver is a retractable patch led. Its basic functions are as follows:

Show.

surface 3.7 Indicator lamp definition

name	Function	illustrate
green led	Power supply, parameter saving function indication, Restore factory settings function indication,	When the power is on normally, the green light is always on and the red light is off.
red led	DIP switch status indication, Alarm indicator light	When an abnormality occurs in the equipment, the red and green lights flash alternately to give an alarm. For the flashing pattern, please refer to Chapter 6;

### 3.3 RS485 Communication interface

IRS35(E) All-in-one 485 The communication interface of bus type open (closed) loop stepper driver adopts JST1.25-12P straight pin socket, as shown below:

shown.

Its interfaces have 12 pins, corresponding to the pins from top to bottom 1-12, where pin 9, 10, 11, 12 used for RS485 half-duplex communication,

pinout 9, 10 as a group, 485 Communication A, B Terminal, Pin 11, 12 as a group, the driver internally connects to the pins 9, 10 Cascade, available

The pins are connected to the next drive device, and the other pins have other functions. The pin definitions are as follows:

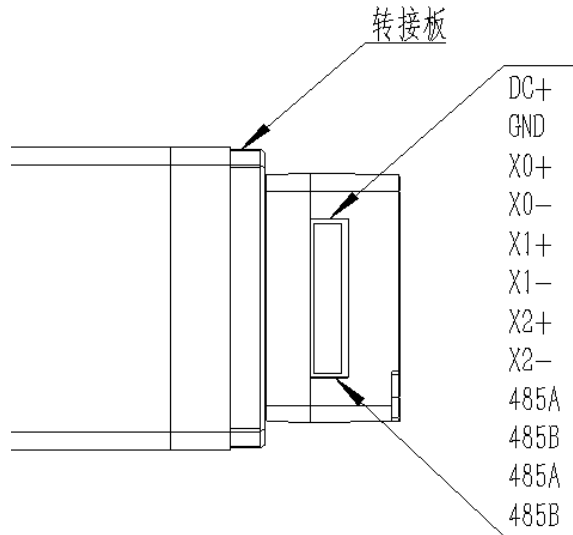

picture 3.2 IRS35(E) All-in-one 485 Bus type open (closed) loop stepper driver interface diagram

surface 3.8 JST1.25-12P Pin Function Distribution

Pinout	definition
X0+, X0-, X1+, X1-, X2+, X2-	enter IO mouth
485A 485B	485 Communication interface A/B end
485A 485B	Connect to the next drive 485 Communication interface A/B end

### 3.4 Input signal interface

#### 3.4.1 Input signal description and wiring diagram

IRS35(E) All-in-one 485 Bus type open (closed) loop stepper driver provides 3 The input is a programmable interface with opto-isolation.

Input interface can be externally connected 5V-24V To ensure reliable conduction of the optocoupler inside the driver, the drive current at the controller end is required to be at least 10mA, the input level pulse width needs to be greater than 10ms, otherwise the drive may not respond properly.

After the driver is powered on normally, the effective level of the input interface is initially set to rising edge or high level by default. The user can also configure the input interface through the master station.

The initial default valid level of the port is the falling edge or low level.

by X0 Taking the input port as an example, the following figure is the wiring diagram of the input signal interface:

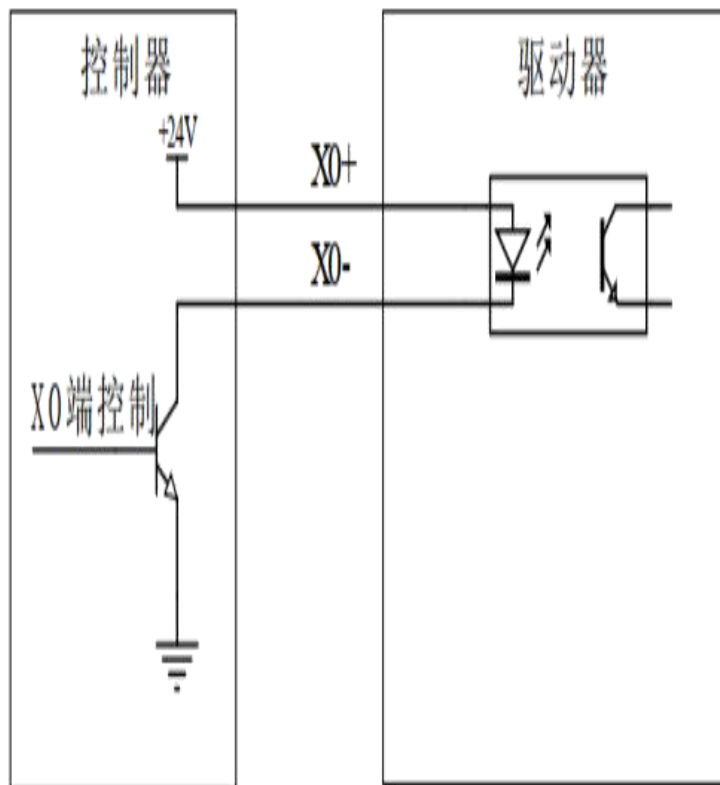

picture3.3 Input signal wiring diagram

**Notice:** IRS35(E) All-in-one 485 Bus type open (closed) loop stepper driver default input interface support DC 5V-24V Signal, no external connection required

resistance.

If the input terminal is connected to a sensor, it supports NPN type and PNP. There are two types of sensor wiring methods: X0. For example, the input port is

The line diagram is shown in the following two figures:

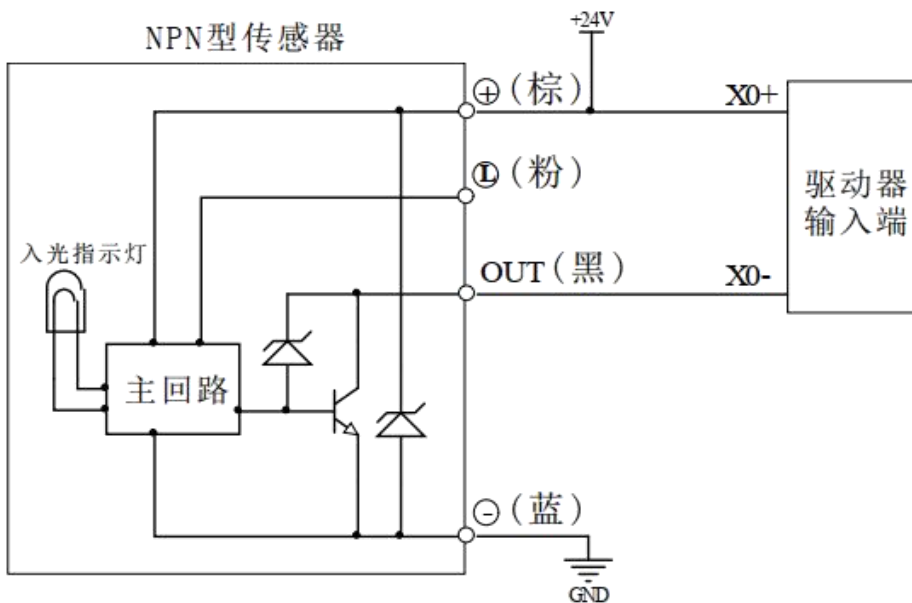

picture3.4 NPNTYPE sensor wiring diagram

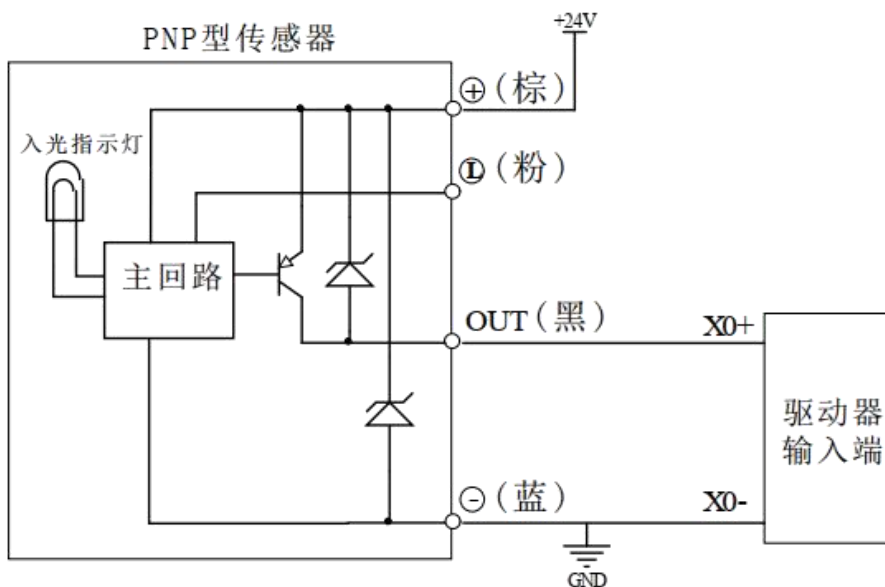

picture3.5 PNPTYPE sensor wiring diagram

**3.4.2 Input signal interface function**

IRS35(E) All-in-one 485 Bus type open (closed) loop stepper driver has a variety of configurable functions in its input port.

Set the corresponding input port function, each input port can be set up to twenty one functions, see the table below.

Table 3.9: Input interface function definition

name		illustrate	Functional Description
Input signal interface	X0+	DC5V~24V powered by, Support differential signal input	0: undefined; 1: origin signal; 2: Positive limit signal; 3: Negative limit signal; 4: Motor MFE Enable/release signal; 5: Brake control input signal; 6: Alarm clear signal; 7: Function code restores factory settings signal; 8: Normal stop signal; 9: Emergency stop signal; 10: Trigger position mode motion (relative and absolute position Mode by register 0x0036 choose); 11: Trigger speed mode movement; 12: JOG+ Point movement; 13: JOG- Point movement; 14: Return to origin enable signal (sent in conjunction with return to origin mode Memory usage); 15: PTIN0; 16: PTIN1; 17: PTIN2; 18: PTIN3; 19: PTIN4(reserve); 20: Multi-segment position mode start signal; twenty one: Clear the in-place output signal; Note: In the above function selection: 4, 5, 12, 13, 15-20 The signal is high or low level valid. They are all valid on the rising or falling edge;
	X0-		
	X1+		
	X1-		
	X2+		
	X2-		

### 3.4.3 Input signal interface function description

The input signal interface function description is as follows:

Input interface function description

Function	describe
1: Origin signal	Connect the origin sensor;
2: Positive limit signal	Connect the positive limit sensor;
3: Negative limit signal	Connect to negative limit sensor;
4: Motor enable/release signal	Enable signal, which makes the motor enter the lock or release state;
5: Brake control input signal	Control the brake motor to hold or release the brake;
6: Alarm clear signal	EEPROM Read and write errors, communication errors recovery; Automatic recovery from overvoltage and undervoltage;
7: Parameters are restored to factory settings signal	Parameters are restored to factory settings;
8: Normal stop signal	The motor decelerates and stops;
9: Emergency stop signal	The motor not only over-decelerates but stops directly;
10: Trigger position mode motion	By Register 0x0030~0x0036 Set up movement;
11: Trigger speed mode motion	By Register 0x0030~0x0036 Set up movement;
12: JOG+ Point movement	By Register 0x0046~0x0049 Set up movement;
13: JOG- Point movement	By Register 0x0046~0x0049 Set up movement;
14: Return to origin enable signal	Trigger the return to origin function;
15: PTIN0	Multi-segment mode path number setting;
16: PTIN1	
17: PTIN2	
18: PTIN3	
19: PTIN4(reserve)	
20: Multi-stage mode start signal	Start multi-stage mode motion;
twenty one: Clear the in-position output signal	If the output port in-place signal function is enabled, this function can be used to clear the in-place output. Send out a signal;

### 3.5 Power input interface

name		illustrate	Function
VDC	DC+	Power interface	Power Input DC12V~40V
	GND		

## Four,MODBUSCommunication protocols and functions

### 4.1Basic communication parameters

surface4.1Basic communication parameters

name	describe	Remark
Hardware Interface	RS485	Not supportedRS232
Communication Type	Asynchronous half-duplex	Communication between master and slave devices
Baud rate	9600(default)	Can be set by dial code or host computer
Communication Protocol	MODBUS-RTU	-
Function code	0x03: Read single or multiple data 0x06: Write single data 0x10: Write multiple data	-
Data character composition	Start position:1Bit Data bits:8Bit Parity: None (default)/Odd/Even Stop bits:1Bit(Default)/2Bit	Communication data format
Verification method	CRC16	Low position in front, high position in the back
Number of devices	15(Default)	Higher adjustable

#### 485Bus single message communication rate:

Baud rate	Time from start of receiving to completion of sendingT1 (ms)
115200	3.49
38400	6.30
19200	10.46
9600	20.32

When multiple axes send messages continuously, there will be aPLCProcessing wait timeT2, this value varies depending on the master station and baud rate.

## 4.2 MODBUSRegister address definition

### 4.2.1Status parameter group (read only)

surface4.2Status parameter group register

Register Address	project	illustrate	Setting range <small>Note: Other values are invalid.</small>	default value
<b>Status parameter group (read-only)</b>				
0x0000	Driver version	Driver version;	(read only)	-
0x0001	Drive Label	The same series of product labels, used to distinguish common products Products and customized products;	(read only)	-
0x0002	Drive Node Number	MODBUSCurrent communication slave node number;	(read only)	-
0x0003	Driver working mode	correspondBitPosition1Indicates the currently running working mode Mode; 0x01: Speed mode trigger; 0x02: Relative position mode trigger; 0x04: Absolute position mode trigger; 0x08: Trigger the return to origin mode; 0x1P: Multi-segment position mode,PFor the corresponding road Path segment,PThe value range is0-15; 0x2P: Multi-speed mode,PFor the corresponding road Path segment,PThe value range is0-15; 0x40:JOG+sports; 0x80:JOG-sports; Other values: invalid;	(read only)	-
0x0004	Drive Status	Bit0: Release/enable status; 0:release; 1: enable; Bit1: static/moving state; 0:still; 1:sports; Bit2-Bit3: Return to zero state; 0:invalid; 1: Returning to the origin; 2: Return to origin completed; Bit4-Bit5: Motor movement direction; 0: Invalid, stop state; 1: positive direction;	(read only)	-

		<p>2: reverse direction;</p> <p><b>Bit6: Alarm status;</b></p> <p>0:normal;</p> <p>1:Call the police;</p> <p><b>Bit7~Bit15:reserve;</b></p>		
0x0005	Current given theoretical speed	<p>The current theoretical running speed value given in real time;</p> <p><b>unit:rev/min</b></p> <p>This variable can be used to view the theoretical running trajectory of the motor;</p>	(read only)	-
0x0006	Current actual running speed	<p>The current actual running speed value;</p> <p><b>unit:rev/min</b></p>	(read only)	-
0x0007	Current error code	<p>0:normal;</p> <p>Other values: error code (see4.2.13subsection);</p> <p><b>Note:</b>Suggested Query Register0x019A, 0x019C~0x019DGet alarm information;</p>	(read only)	-
0x0008	Current error subcode	<p>The error subcode corresponding to the current error code;</p> <p>0:normal;</p> <p>Other values: Error subcode (see4.2.13Section) ;</p> <p><b>Note:</b>Suggested Query Register0x019A, 0x019C~0x019DGet alarm information;</p>	(read only)	-
0x0009	Input Port Status flag	<p>Indicates whether the level of the corresponding input port is valid or invalid;</p> <p><b>Bit0:X0Port input status;</b></p> <p><b>Bit1:X1Port input status;</b></p> <p><b>Bit2:X2Port input status;</b></p> <p><b>Bit3~Bit15:reserve;</b></p> <p>0: The input level of this port is considered invalid;</p> <p>1: The input level of this port is considered valid;</p>	(read only)	-
0x000A	Output Port Status flag	<p>reserve;</p> <p>IRS35(E) integrated 485 bus open (closed) loop stepper driver has no output port;</p>		
0x000B	Current position low16Bit	<p>The position after returning to the origin or the initial position after power-on</p>	(read only)	-
0x000C	Current position high16Bit	<p>The current position calculated from the zero point (the highest bit)</p> <p>Number position, representing positive and negative directions;</p>	(read only)	-



0x000D	Current actual current	In open-loop and closed-loop modes, the actual Effective current value; <b>unit:mA</b>	(read only)	-
0x000E	currentAPhase current	AReal-time display of phase current; <b>unit:mA</b>	(read only)	-
0x000F	currentBPhase current	BReal-time display of phase current; <b>unit:mA</b>	(read only)	-
0x0010	Closed loop current setting	In closed-loop mode, the current running given effective current value; <b>unit:mA</b>	(read only)	-
0x0011	DIP status	reserve; IRS35(E) integrated 485 bus open (closed) loop stepper driver without dial switch;		
0x0012	PTSegment path number	Low8Bit: Path execution completion status (hold), When the current path is executed, query it for use; high8Bit: If in operation, it indicates the current If the path segment is being executed, or if it is stationary, it means Display the path segment that was completed last time;	(read only)	-
0x0013	reserve;			

4.2.2 Common parameter group1(Read and Write)

surface4.3Common parameter group1register

Register Address	project	illustrate	Setting range Note: Other values are invalid.	default value
Common parameter group1(Open and closed loop sharing)				
0x0014	Driver Node Settings	<p>IRS35(E)All-in-one485Bus type open (closed) loop</p> <p>There is no DIP switch in the driver, the default address is 1, the node number of the drive can be set through this register;</p> <p><b>Note:</b>After modification, save and power on again for it to take effect;</p>	<p>0-65535</p> <p>(Read and Write)</p>	1
0x0015	Custom communication baud Rate	<p>The communication baud rate can be set by the host computer;</p> <p>0:9600 1:14400 2:19200 3:38400 4:115200 5:128000 6:256000</p> <p><b>Note:</b>After modification, save and power on again for it to take effect;</p>	<p>0~6</p> <p>(Read and Write)</p>	0
0x0016	Serial port data format	<p>0:8bit data, no checksum,1stop bits; 1:8bit data, no checksum,2stop bits; 2:8bit data, even parity,1stop bits; 3:8bit data, odd parity,1stop bits;</p> <p><b>Note:</b>After modification, save and power on again for it to take effect;</p>	<p>0~3</p> <p>(Read and Write)</p>	0
0x0017	Save parameter function	<p>correspond to location 1, the corresponding parameter group can be saved;</p> <p>The specific corresponding relationships are as follows:</p> <p>Bit0: Synchronous update function (0x0001), generally not recommended to enable this function;</p> <p>0: Asynchronous update EEPROM; 1: Synchronous update EEPROM;</p> <p>Bit1: reserve;</p> <p>Bit2: Save common parameter groups1(0x0004);</p> <p>Bit3: Save the common open loop parameter group (0x0008);</p> <p>Bit4: Save the closed loop common parameter group (0x0010);</p> <p>Bit5: Save basic control parameter group1(0x0020);</p> <p>Bit6: Save the return to origin parameter group (0x0040);</p> <p>Bit7: Save basic control parameter group2 (0x0080);</p> <p>Bit8: Save common parameter groups2 (0x0100);</p> <p>Bit9: Save multi-segment mode parameter group (0x0200);</p> <p>Bit10: Save performance parameter group (0x0400);</p>	<p>0~65535</p> <p>(Read and Write)</p>	0

		<p>Bit11: Save brake parameter group (0x0800);</p> <p>Bit12: Save status, fault code parameter group (0x1000);</p> <p>Bit13: Save input and output parameter groups (0x2000);</p> <p>Bit14: Save user parameter group (0x4000);</p> <p>Bit15: Save all parameter functions (0x8000);</p> <p>0: Do not save;</p> <p>1: Save all 'read and write' attribute parameters;</p> <p>useBit1~Bit15When saving parameters, the traffic light changes to green.</p> <p>Flash for each2When saving is completed, the green light remains</p> <p>The red light is off. You can also check this through the main station</p> <p>If0, it means the parameters are saved successfully;</p>		
0x0018	Over-travel parking function	<p>correspondBitLocation1, select the corresponding overrun parking Function;</p> <p>Bit0: Free stop/emergency stop mode selection position;</p> <p>0: Free stop (deceleration and stop when overtravel);</p> <p>1: Emergency stop (stop immediately when overtravel);</p> <p>Bit1: Positive and negative hard limit overtravel prohibition function bit;</p> <p>0: Prohibition void;</p> <p>1: Disable validity; (default)</p> <p>Bit2: Positive and negative soft limit overtravel prohibition function bit;</p> <p>0: Prohibition void;</p> <p>1: Disable validity; (default)</p>	0~7 (Read and Write)	6
0x0019	Alarm clear	<p>0:invalid;</p> <p>1: Alarm cleared;</p>	0~1 (Read and Write)	0
0x001A	Parameters restored to factory settings Place	<p>0:invalid;</p> <p>1: Restore factory settings;</p>	0~1 (Read and Write)	0
0x001B	Storage function Enable control	<p>correspondBitLocation1, turn on the corresponding storage function;</p> <p>Bit0: Phase memory enable function;</p> <p>0: Disable;</p> <p>1: enable;</p> <p>Bit1: Function of storing current position after power failure;</p> <p>0: Disable;</p> <p>1: enable;</p>	0~3 (Read and Write)	0
0x001C	Open/closed loop mode switching/ Initial rotation direction switch	<p>IRS35(E)All-in-one485Bus type open (closed) loop</p> <p>The driver can be set to open or close by the host computer</p> <p>Ring pattern and initial rotation direction;</p> <p>Bit0: Open-closed loop mode switching;</p> <p>0: Open loop mode;</p>	0~3 (Read and Write)	-

		<p>1: Closed loop mode;</p> <p>Bit1: Initial rotation direction switch;</p> <p>0: Factory default rotation direction;</p> <p>1: Opposite to the factory default rotation direction;</p> <p><b>Note:</b>After modification, save and power on again for it to take effect;</p>		
0x001D	Return to origin timeout alarm set up	In the return to origin mode, the timeout alarm time is set; unit:s	0~4000 (Read and Write)	1000

4.2.3 Common parameter group in open loop mode (read and write)

surface4.4 Open-loop mode common parameter group register

Register Address	project	illustrate	Setting range <small>Note: Other values are invalid.</small>	default value
Common parameter groups in open loop mode				
0x001E	Open loop current setting	The effective current value in open-loop mode can be adjusted arbitrarily; unit:mA	0~6000 (Read and Write)	-
0x001F	Open loop subdivision setting	Arbitrarily set the subdivision value in open-loop mode; unit:Pul/rev	200~60000 (Read and Write)	10000
0x0020	Open loop soft start time	unit:ms	1~65535 (Read and Write)	200
0x0021	Open loop lock machine current time	The time required for the open loop to go from running to locking state; unit:ms	1~3000 (Read and Write)	200
0x0022	Open loop lock current ratio	Set the lock current percentage in open loop mode; unit:%	0~100 (Read and Write)	50
0x0023	Open-loop algorithm selection	0:Aalgorithm; 1:BAalgorithm (reserved); <b>Note:</b> After modification, save and power on again for it to take effect;	0~1 (Read and Write)	0

4.2.4 Closed-loop mode common parameter group (read and write)

surface4.5 Closed-loop mode common parameter group register

Register Address	project	illustrate	Setting range Note: Other values are invalid.	default value
Common parameter groups in closed loop mode				
0x0024	Closed loop operation minimum effective Current setting	The minimum effective current value of closed-loop operation can be adjusted arbitrarily; <b>unit:mA</b>	0~6000 (Read and Write)	-
0x0025	Closed loop operation is most effective Current setting	The maximum effective current value of closed-loop operation can be adjusted arbitrarily; <b>unit:mA</b>	0~6000 (Read and Write)	-
0x0026	Closed loop lock machine minimum effective Current setting	The minimum effective current value of the closed-loop locking machine can be adjusted arbitrarily; <b>unit:mA</b>	0~6000 (Read and Write)	-
0x0027	Closed loop lock machine maximum current set up	The maximum effective current value of the closed-loop locking machine can be adjusted arbitrarily; <b>unit:mA</b>	0~6000 (Read and Write)	-
0x0028	Closed-loop subdivision settings	The subdivision value in closed-loop mode can be set arbitrarily; <b>unit:Pul/rev</b>	200~60000 (Read and Write)	10000
0x0029	Closed loop soft start timeT1	<b>unit:ms</b>	1~65535 (Read and Write)	410
0x002A	Closed loop soft start timeT2	<b>unit:ms</b>	1~65535 (Read and Write)	1000
0x002B	Closed loop lock time	The closed loop switches from the running state to the in-position signal output Time required for status; <b>unit:ms</b>	1~500 (Read and Write)	2
0x002C	Closed loop position out-of-tolerance alarm value	Set the out-of-tolerance alarm angle value; <b>unit:1 represent 0.09°</b>	1~65535 (Read and Write)	4000
0x002D	Closed loop out-of-tolerance alarm time	The accumulated time from the deviation to the output of alarm signal; <b>unit:ms</b>	1~1000 (Read and Write)	10
0x002E	Torque mode selection	0: Normal closed loop mode (will enter out-of-tolerance alarm, also Will output an alarm signal); 1: Normal closed-loop torque mode (will not enter the out-of-tolerance alarm Alarm, but can output alarm signal);	0~2 (Read and Write)	0

		<p>2: Normal closed loop torque mode2(Will not enter out of tolerance Alarm, no alarm signal will be output);</p>		
0x002F	Closed-loop algorithm selection	<p>Bit0: Operation mode selection bit;                  0: Operation control modeA;                  1: Operation control modeB;</p> <p>Bit1: Current control mode selection bit;                  0: Current control methodA;                  1: Current control methodB;</p> <p>Bit2: Lock control mode selection bit;                  0: Lock control modeA;                  1: Lock control modeB;</p> <p>Bit3: Closed loop locking mode after power-on;                  0: After power on, lock modeA;                  1: After power on, lock modeB;</p> <p>Bit4: Closed-loop algorithm selection;                  0: Closed-loop algorithmA;                  1: Closed-loop algorithmB;</p> <p><b>Note:</b>After modification, power on again to take effect;</p>	<p>0~31                  (Read and Write)</p>	0

4.2.5 Driver basic control parameter group1(Read and Write)

surface4.6 Driver basic control parameter group register

Register Address	project	illustrate	Setting range Note: Other values are invalid.	default value
<b>Driver basic control parameter group1(Open and closed loop sharing)</b>				
0x0030	Starting speed	Set the starting speed of the motor; unit:rev/min	1-3000 (Read and Write)	5
0x0031	Acceleration time	Acceleration time; unit:ms	0~2000 (Read and Write)	100
0x0032	Deceleration time	Deceleration time; unit:ms	0~2000 (Read and Write)	100
0x0033	Maximum speed	Set the maximum speed of the motor; unit:rev/min  <b>Note:</b> In speed mode, the positive and negative values of the set values are used to determine the direction of rotation. The setting rules for negative values can be: Reference register'0x0034~0x0035Total pulse number' Introduction;	- 3000~3000 (Read and Write)	60
0x0034	Total pulse count low16Bit	In position mode, the total number of pulses of the motor running includes: The total number of steps in the three stages of acceleration, constant speed and deceleration; The highest bit represents the sign bit, and a positive number indicates positive direction. The negative number indicates the pulse number of the reverse direction.  Number of impulses; <b>Note:</b> If set 100000(Original code:0x0001 86A0) pulses, the high bit set value is 0x0001, Low	- 2147483648~ 2147483648 (Read and Write)	5000
0x0035	Total pulse count high16Bit	The bit value is 0x86A0; If set -100000(Original code:0x8001 86A0) individual Pulse, because negative numbers are stored in the form of complement code, The high setting value is 0xFFFF, the low given value is 0x7960;  The given pulse number in the reverse direction can be calculated using the following formula: $2^{32} - \text{abs}(\text{The number of pulses given in the reverse direction})$		
0x0036	Relative position/absolute position Setting selection	When you choose to use external I/O signal trigger position mode  This bit setting is effective when it is in operation; 0: Relative position: take the current static point as the starting point; 1: Absolute position: above power-on position or return to original position  The point after completion is the starting point;	0~1 (Read and Write)	0

0x0037	Startup Command	<p>correspondBitLocation1Can trigger the start of corresponding work model;</p> <p>0x01: Speed mode trigger;</p> <p>0x02: Relative position mode trigger;</p> <p>0x04: Absolute position mode trigger;</p> <p>0x08: Trigger the return to origin mode;</p> <p>0x1P: Multi-segment (position/speed) mode trigger start, PFor the corresponding path segment,PTThe value range is 0-15The specific trigger is the position or speed operation.</p> <p>OK, follow the path function register1related;</p> <p>0x40:JOG+sports;</p> <p>0x80:JOG-sports;</p> <p>Other values: reserved;</p>	0~255 (Read and Write)	0
0x0038	Stop Command	<p>0: Normal stop;</p> <p>1: Emergency stop;</p> <p>2: Run at the set speed or along the planned track</p> <p>The trace runs until it stops;</p>	0~2 (Read and Write)	2
0x0039	Motor enable // release Order	<p>The motor enable/release function can be controlled by command or external departmentIOInput signal for control.</p> <p>The following is the register corresponding toBitFunction of bits:</p> <p>Bit0: Soft enable bit;</p> <p>0:release;</p> <p>1: enable;</p> <p>Bit1: Initially powered on, the motor self-enables the control position;</p> <p>0: After power on, the motor is in the released state.</p> <p>passBit0Place1Enable motor lock shaft;</p> <p>1: After power on, the motor is in the locked state, but</p> <p>You can alsoBit0Place0Release the motor;</p> <p><b>Note:</b>If a certain input port function is configured as 4(MotorMFEEnable/release signal), only when the RegisterBit0Position0hour,IOPort Enable/</p> <p>The function of releasing the motor is effective;</p>	0~3 (Read and Write)	0
0x003A	Clear current location	<p>In absolute position mode, clear the current position value;</p> <p>0:invalid;</p> <p>1: Current location clear0;</p>	0~1 (Read and Write)	0



4.2.6 Return to origin parameter group (read and write)

surface4.7 Return to origin parameter group register

Register Address	project	illustrate	Setting range Note: Other values are invalid.	default value
Return to origin parameter group (shared for open and closed loop)				
0x003B	Return to origin mode	Currently, the return to zero mode can be set to 17-30, 33-35, 37-39、(-3)-(-6); <b>Note:</b> The highest bit represents the sign bit; <small>For details on how to return to the original state, please refer to the chapter '5.3 Back to origin mode';</small>	0~65535 (Read and Write)	0
0x003C	Return to origin speedV1	In the homing mode, the speed of the origin is detected at high speed; <b>unit:rev/min</b> <b>Note:</b> The starting speed of the high-speed detection origin is '0x003D Return to origin speedV2';	1~3000 (Read and Write)	30
0x003D	Return to origin speedV2	In the homing mode, the origin is detected at low speed or compensation is performed  The speed of the value; <b>unit:rev/min</b> <b>Note:</b> Low speed detection origin or starting speed of compensation value <b>Degree0;</b>	1~300 (Read and Write)	10
0x003E	Acceleration time to return to origin	Acceleration time during return to origin; <b>unit:ms</b>	0 ~2000 (Read and Write)	100
0x003F	Deceleration time when returning to origin	Deceleration time during return to origin; <b>unit:ms</b>	0 ~2000 (Read and Write)	100
0x0040	Origin low position compensation value	Position compensation value after returning to the origin;  The highest bit represents the sign bit, and a positive value represents positive compensation  Value, negative value represents negative compensation value; <b>Note:</b> If set 100000(Original code:0x0001 86A0) pulses, the high bit set value is 0x0001, Low The bit value is 0x86A0;	- 2147483648~ 2147483648 (Read and Write)	0
0x0041	Origin high position compensation value	If set -100000(Original code:0x8001 86A0) individual Pulse, because negative numbers are stored in the form of complement code, The high setting value is 0xFFFFE, the low given value is 0x7960;  The given pulse number in the reverse direction can be calculated using the following formula:  $2^{32}-abs(\text{The number of pulses given in the reverse direction})$		
0x0042	Stall return to zero torque retention <b>time</b>	<b>unit:ms</b>	0-65535 (Read and Write)	100

0x0043	Return to zero current percentage	unit:%	1~300	100
0x0044	Open and closed loop position return to zero Position value low16Bit	In open-loop and closed-loop position return mode, the maximum running Row position value, unsigned;	0~4294967295 (Read and Write)	5000
0x0045	Open and closed loop position return to zero Position value high16Bit			

4.2.7 Driver basic control parameter group2(Read and Write)

surface4.8 Driver basic control parameter group2 register

Register Address	project	illustrate	Setting range <small>Note: Other values are invalid.</small>	default value
Driver basic control parameter group2(Open and closed loop sharing)				
0x0046	JOGMovement starting speed	Unsigned unit:rev/min	1~3000 (Read and Write)	2
0x0047	JOGMovement acceleration speed	unit:ms	0~2000 (Read and Write)	2
0x0048	JOGMovement deceleration speed	unit:ms	0~2000 (Read and Write)	2
0x0049	JOGMaximum speed of movement	Unsigned; unit:rev/min	0~3000 (Read and Write)	30
0x004A~ 0x0055	reserve;			

4.2.8 Common parameter group2(Read and Write)

surface4.9 Common parameter group2 register

Register Address	project	illustrate	Setting range Note: Other values are invalid.	default value
Common parameter group2(Open and closed loop sharing)				
0x0056	Positive overtravel maximum position Low16Bit	Unsigned; unit:Pul	0~2147483647 (Read and Write)	2147483647
0x0057	Positive overtravel maximum position high16Bit			
0x0058	Reverse overtravel maximum position Low16Bit	Unsigned; unit:Pul	0~2147483647 (Read and Write)	2147483647
0x0059	Reverse overtravel maximum position high16Bit			
0x005A	Automatically return to zero point after power on Enable	<p>If this function is enabled, the driver will automatically Yes, and execute the zero point return action, but please note that Set and save the zero return mode parameter value in advance.</p> <p>The zero return action can be performed normally only after power is turned on;</p> <p>0: The automatic return to zero point function after power on is disabled;</p> <p>1: Enable the automatic return to zero point function after power on;</p>	0~1 (Read and Write)	0
0x005B~ 0x005D	reserve;			

4.2.9 Input function parameter group (read and write)

surface4.10 Input function parameter group register

Register Address	project	illustrate	Setting range Note: Other values are invalid.	default value
Input function parameter group (shared for open and closed loop)				
0x01B0	Input Port Effective level	Bit0: Input portX0Control bit; Bit1: Input portX1Control bit; Bit2: Input portX2Control bit; Bit3~Bit15:reserve;  0: Rising edge or high level is valid; 1: Falling edge or low level is valid;	0~65535  (Read and Write)	0
0x01B1	Input PortX0 Feature selection	0: undefined;		1
0x01B2	Input PortX1 Feature selection	1: origin signal; 2: Positive limit signal; 3: Negative limit signal; 4: MotorMFEEnable/release signal (register 0x0039The value of 1~3When the input control function can be invalid);		2
0x01B3	Input PortX2 Feature selection	5: Brake control input signal; 6: Alarm clear signal; 7: Parameters are restored to factory settings; 8: Normal stop signal; 9: Emergency stop signal; 10: Trigger position mode motion (relative and absolute position Set mode through register0x0036choose); 11: Trigger speed mode movement; 12:JOG+Point movement; 13:JOG-Point movement; 14: Return to origin enable signal (in conjunction with return to origin mode Register usage); 15:PTIN0; 16:PTIN1; 17:PTIN2; 18:PTIN3; 19:reserve; 20: Multi-stage mode start signal (TRIG); twenty one: Clear the in-place output signal;  Note: In the above function selection:4,5,12,13, 15-20The signal is high or low level valid, Others are valid on the rising or falling edge;		0~21  (Read and Write)

0x01B4~ 0x01BB	reserve			
0x01BC	Input PortX0 Filter time	Set the input portX0-X2The filtering time is Small resolution1000us; unit:us	0~65535 (Read and Write)	1000
0x01BD	Input PortX1 Filter time			1000
0x01BE	Input PortX2 Filter time			1000
0x01BF~ 0x01CF	reserve;			

4.2.10 Multi-segment mode parameter group (read and write)

surface4.11 Multi-segment mode parameter group register

Register Address	project	illustrate	Setting range Note: Other values are invalid.	default value
<b>Multi-position mode parameter group (shared for open and closed loop)</b>				
0x005E	Multi-stage mode start signal Enable control	0: Multi-stage mode does not require a start signal (in this case, path0Invalidation); 1: Multi-stage mode requires a start signal (in this case, the path 0 can be started);	0-1 (Read and Write)	1
0x005F	Multi-segment mode IO combination Filter time	Set up multi-segment IO Combinatorial logic filter time, minimum Resolution 1000us; unit:us	0~65535 (Read and Write)	1000
0x0060	path0Function settings1	In multi-segment mode, the path0Function settings1:right CorrespondingBitBit setting, you can select the corresponding function; Bit0: Position/speed mode selection bit; 0: Position mode; 1: speed mode; Bit1: Relative/absolute position mode selection bit; 0: relative position; 1: absolute position; Bit2: IO In-position output signal is prohibited; 0: Prohibition void; 1: prohibition is effective; Bit3: Jump function enable bit; 0: Jump is prohibited; 1: Enable jump; Bit4~Bit7: Jump path selection bit; Setting value range:0-15; Bit8~Bit15:reserve; <b>Note:</b> In multi-speed mode, the jump function is not supported;	0~65535 (Read and Write)	0
0x0061	path0Function settings2	In multi-segment mode, the path0Function settings2:right CorrespondingBitBit setting, you can select the corresponding function; Bit0: Return to origin enable bit; 0: prohibit the path from returning to the origin; 1: Enable the path to return to the origin; Bit1: Whether to execute the path after returning to the original state; 0: Prohibit execution of this path; 1: Enable execution of this path; Bit2: Selection of return to origin parameters; 0: Optional 0x003C-0x0041 speed, increase	0~65535 (Read and Write)	0

		<p>Deceleration time and return to original compensation value parameters;</p> <p>1: Select the speed, acceleration and deceleration time of this path segment</p> <p>Time, return to original compensation value parameters;</p> <p><b>Bit3-Bit7:reserve;</b></p> <p>Bit8-Bit15: Return to origin mode selection position; return to origin</p> <p>For details, see chapter '5.3Back to origin mode';</p>		
0x0062	<p>path0Location segment</p> <p>Total pulse count low</p>	<p>In the multi-segment position mode, it is used to set the path segment operation.</p> <p>The total number of pulses in the line, including acceleration, uniform speed, and deceleration</p> <p>Total number of steps in the three phases;</p> <p>The highest bit represents the sign bit, and a positive number indicates positive direction.</p> <p>The negative number indicates the pulse number of the reverse direction.</p> <p>Number of impulses;</p> <p><b>Note:</b>If set 100000(Original code:0x0001 86A0) pulses, the high bit set value is0x0001,Low The bit value is0x86A0;</p> <p>If set -100000(Original code:0x8001 86A0)individual Pulse, because negative numbers are stored in the form of complement code,</p> <p>The high setting value is0xFFFE, the low given value is 0x7960;</p> <p>The given pulse number in the reverse direction can be calculated using the following formula:</p> <p><math>2^{32}-abs(\text{The number of pulses given in the reverse direction})</math></p>	<p>- 2147483648~ 2147483648</p> <p>(Read and Write)</p>	0
0x0063	<p>path0Location segment</p> <p>Total pulse count high</p>	<p>(1) In multi-stage position/speed mode, set the corresponding The maximum speed at which the motor runs within the path;</p> <p>(2) If the path segment has the return to origin function enabled, and Register' path function setting2'ofBit2Location1, Then the speed of returning to the originV1'Use this register value;</p> <p><b>unit:rev/min</b></p> <p><b>Note:</b> (1) In multi-speed mode, according to the setting The positive or negative value determines the direction of the motor's rotation; a negative value</p> <p>For setting rules, please refer to register '0x0034-0x0035Total number of pulses' introduction;</p> <p>(2) Multi-position mode and zero return speed setting</p> <p>The value must be guaranteed to be positive;</p>	<p>- 3000~3000</p> <p>(Read and Write)</p>	60
0x0064	<p>path0Run/Return to origin</p> <p>Maximum speed</p>	<p>(1) In multi-stage position/speed mode, set the corresponding The starting speed of the motor within the path;</p> <p>(2) If the path segment has the return to origin function enabled, and Register' path function setting2'ofBit2Location1, Then the speed of returning to the originV2'Take this value;</p> <p><b>unit:rev/min</b></p>	<p>1~3000</p> <p>(Read and Write)</p>	5
0x0065	<p>path0Run/Return to origin</p> <p>Starting speed</p>	<p>(1) In multi-stage position/speed mode, set the corresponding The starting speed of the motor within the path;</p> <p>(2) If the path segment has the return to origin function enabled, and Register' path function setting2'ofBit2Location1, Then the speed of returning to the originV2'Take this value;</p> <p><b>unit:rev/min</b></p>	<p>1~3000</p> <p>(Read and Write)</p>	5

0x0066	path0Run/Return to origin Acceleration time	(1) In multi-stage position/speed mode, set the corresponding Acceleration time within the path; (2) If the path segment has the return to origin function enabled, and Register' path function setting2'ofBit2Location1, Then the 'acceleration time to return to origin' adopts this register value; <b>unit:ms</b>	0~2000 (Read and Write)	100
0x0067	path0Run/Return to origin Deceleration time	(1) In multi-stage position/speed mode, set the corresponding deceleration time within the path; (2) If the path segment has the return to origin function enabled, and Register' path function setting2'ofBit2Location1, Then the 'return to origin deceleration time' adopts this register value; <b>unit:ms</b>	0~2000 (Read and Write)	100
0x0068	path0Execution completed Waiting time	In multi-segment loop mode, the current path segment is executed. Finish, the waiting time until the next path segment is executed; <b>unit:ms</b>	0~65535 (Read and Write)	0
0x0069	path0Back to origin Low compensation value	In multi-segment mode, the position of the current path after returning to the origin Compensation value; The highest bit represents the sign bit, and a positive value represents positive compensation		
0x006A	path0Back to origin High compensation value	Value, negative value represents negative compensation value; Note: If you set100000(Original code:0x0001 86A0) pulses, the high bit set value is0x0001,Low The bit value is0x86A0; If set -100000(Original code:0x8001 86A0)individual Pulse, because negative numbers are stored in the form of complement code, The high setting value is0xFFFF, the low given value is 0x7960; The given pulse number in the reverse direction can be calculated using the following formula: $2^{32}-abs(\text{The number of pulses given in the reverse direction})$	- 2147483648~ 2147483648 (Read and Write)	0
0x006B	path0After returning to the origin Waiting time	In multi-segment mode, the path0After returning to the origin, The waiting time for executing the path segment; <b>unit:ms</b>	0~65535 (Read and Write)	0
0x0070~ 0x007B	Control Path0Function, Path1Related setting registers, occupying12Registers			
0x0080~ 0x008B	Control Path0Function, Path2Related setting registers, occupying12Registers			
0x0090~ 0x009B	Control Path0Function, Path3Related setting registers, occupying12Registers			
0x00A0~ 0x00AB	Control Path0Function, Path4Related setting registers, occupying12Registers			
0x00B0~ 0x00BB	Control Path0Function, Path5Related setting registers, occupying12Registers			



0x00C0~ 0x00CB	Control Path0Function, Path6Related setting registers, occupying12Registers
0x00D0~ 0x00DB	Control Path0Function, Path7Related setting registers, occupying12Registers
0x00E0~ 0x00EB	Control Path0Function, Path8Related setting registers, occupying12Registers( <b>reserve</b> )
0x00F0~ 0x00FB	Control Path0Function, Path9Related setting registers, occupying12Registers( <b>reserve</b> )
0x0100~ 0x010B	Control Path0Function, Path10Related setting registers, occupying12Registers( <b>reserve</b> )
0x0110~ 0x011B	Control Path0Function, Path11Related setting registers, occupying12Registers( <b>reserve</b> )
0x0120~ 0x012B	Control Path0Function, Path12Related setting registers, occupying12Registers( <b>reserve</b> )
0x0130~ 0x013B	Control Path0Function, Path13Related setting registers, occupying12Registers( <b>reserve</b> )
0x0140~ 0x014B	Control Path0Function, Path14Related setting registers, occupying12Registers( <b>reserve</b> )
0x0150~ 0x015B	Control Path0Function, Path15Related setting registers, occupying12Registers( <b>reserve</b> )
Note:0x0060~0x015FThe registers not used in the interval are reserved registers of each path and have no function at present;	

4.2.11 Performance parameter group (read and write)

surface4.12 Performance parameter group register

Register Address	project	illustrate	Setting range Note: Other values are invalid.	default value
Performance parameter group				
0x0160	Phase loss detection threshold	Set the threshold value in the phase loss detection function; <b>Note:</b> After modification, save and power on again for it to take effect;	0~100 (Read and Write)	-
0x0161	Closed loop current setting Control factor adjustment	Closed-loop current given control factor adjustment percentage; <b>unit:%</b>	0~500 (Read and Write)	100
0x0162	Intermediate frequency oscillation processing enable	0: Oscillation processing is turned off; 1: Oscillation processing is enabled;	0~1 (Read and Write)	1
0x0163	Medium frequency oscillation Inhibition coefficientK	Medium frequency oscillation suppression coefficientKAdjustment percentage; <b>unit:%</b>	0~500 (Read and Write)	100
0x0164	Medium frequency oscillation Starting speedV1	Set the starting speed of the medium frequency oscillationV1; <b>unit:rev/min</b>	1~2000 (Read and Write)	-
0x0165	Medium frequency oscillation Maximum speedV2	Set the maximum speed of the medium frequency oscillationV2; <b>unit:rev/min</b>	1~2000 (Read and Write)	-
0x0166	Motor winding resistance adjustment	Motor winding resistance adjustment percentage; <b>unit:%</b>	0~500 (Read and Write)	100
0x0167	Open current loop Parameter adjustment enable	0:PIParameter adjustment is disabled 1:PIParameter adjustment enable	0~1 (Read and Write)	0
0x0168	Open current loop Proportional Gain	Open-loop current loop proportional gain adjustment percentage; <b>unit:%</b>	0~500 (Read and Write)	100
0x0169	Open current loop Integral gain	Open-loop current loop integral gain adjustment percentage; <b>unit:%</b>	0~500 (Read and Write)	100
0x016A	Open circumferential shaft Proportional Gain	Open-loop axis proportional gain adjustment percentage; <b>unit:%</b>	0~500 (Read and Write)	100
0x016B	Open circumferential shaft Integral gain	Open loop axis integral gain adjustment percentage; <b>unit:%</b>	0~500 (Read and Write)	100

0x016C	Open loop proportional gain Adaptive adjustment enable	0: Proportional gain adaptive adjustment is disabled 1: Proportional gain adaptive adjustment enable	0~1 (Read and Write)	0
0x016D	Open loop proportional gain Adaptive start ratio	Open loop proportional gain adaptive starting proportional adjustment percentage; For example: Set the value to625, then the corresponding open loop proportional gain The starting ratio of the adaptive benefit is0.625times;	1~1000 (Read and Write)	800
0x016E	Open loop proportional gain Adaptive start speedV1	Open loop proportional gain adaptive starting speedV1; unit:rev/min	1~2000 (Read and Write)	60
0x016F	Open loop proportional gain Adaptive turning speedV2	Open loop proportional gain adaptive turning speedV2; unit:rev/min	1~2000 (Read and Write)	900
0x0170	Open loop proportional gain Adaptive Limiting	Open loop proportional gain adaptive limit percentage; unit:%	100~500 (Read and Write)	150
0x0171	Open loop current Adaptive adjustment enable	0: Current adaptive regulation is disabled 1: Current adaptive regulation enabled	0~1 (Read and Write)	0
0x0172	Open loop current Adaptive Adjustment Starting speedV1	Open loop current adaptively adjusts the starting speedV1; unit:rev/min	1~2000 (Read and Write)	-
0x0173	Open loop current Adaptive Adjustment Maximum speedV2	Open loop current adaptive regulation of maximum speedV2; unit:rev/min	1~2000 (Read and Write)	-
0x0174	Open loop current Adaptive Adjustment Maximum limit	Open loop current adaptive regulation maximum limit adjustment percentage; unit:%	100~200 (Read and Write)	120
0x0175	Open and closed loop power-up current Percentage adjustment	unit:%	0~500 (Read and Write)	100
0x0176	Brake control duty cycle adjust	byDC24VAs the reference voltage, adjust the brake control The proportion of interface output voltage; unit:%	0~110 (Read and Write)	96
0x0177	Closed current loop Scale factor	Closed-loop current loop proportional coefficient gain adjustment percentage; unit:%	0~500 (Read and Write)	100
0x0178	Closed current loop Integration coefficient	Closed-loop current loop integral coefficient gain adjustment percentage; unit:%	0~500 (Read and Write)	100
0x0179	Closed loop position loop Scale factor	Closed-loop position loop proportional coefficient adjustment percentage; unit:%	0~500 (Read and Write)	100

0x017A	Closed loop position loop Integration coefficient	Closed-loop position loop integral coefficient adjustment percentage; <b>unit:%</b>	0~500 (Read and Write)	100
0x017B	Closed loop lock current Scale factor	Closed-loop lock machine current proportional coefficient adjustment percentage; <b>unit:%</b>	0~500 (Read and Write)	100
0x017C	Closed loop lock current Integration coefficient	Closed-loop lock machine current integral coefficient adjustment percentage; <b>unit:%</b>	0~500 (Read and Write)	100
0x017D	Closed speed loop Scale factor	Closed-loop speed loop proportional coefficient adjustment percentage; <b>unit:%</b>	0~500 (Read and Write)	100
0x017E	Closed speed loop Feed forward coefficient	Closed-loop speed loop feedforward coefficient adjustment percentage; <b>unit:%</b>	0~500 (Read and Write)	100
0x017F	Closed loop set speed Filter coefficientF1	Closed loop given speed filter coefficientF1Adjustment Percent Compare; <b>unit:%</b>	0~500 (Read and Write)	100
0x0180	Closed loop set speed Filter coefficientF2	Closed loop given speed filter coefficientF2Adjustment Percent Compare; <b>unit:%</b>	0~500 (Read and Write)	100
0x0181	Encoder feedback speed Filter coefficientF1	Encoder feedback speed filter coefficientF1Adjustment Percent Compare; <b>unit:%</b>	0~500 (Read and Write)	100
0x0182	Encoder feedback speed Filter coefficientF2	Encoder feedback speed filter coefficientF2Adjustment Percent Compare; <b>unit:%</b>	0~500 (Read and Write)	100
0x0183	Incremental closed loop encoder Line number setting	The encoder line number can be set by the host computer; 0:1000Wire;      1:1250Wire; 2:2000Wire;      3:2500Wire; 4:5000Wire;      5:10000Wire; 6:625Wire;        7:500Wire; 8:400Wire;        9:250Wire; 10:200Wire;       11:125Wire; 12:100Wire;       13:80Wire; 14:50Wire; <b>Note:</b> (1)After modification, save and power on again for it to take effect; (2)If you need other line numbers, please contact us first. Get in touch to change;	0~14 (Read and Write)	0
0x0184	Closed-loop locking machine positioning accuracy Threshold1	Set the positioning accuracy threshold of the closed-loop locking machine; <b>unit:0.1Encoder value</b>	0~65535 (Read and Write)	25

0x0185	Closed loop lock current Dynamic adjustment parameters1	Closed-loop lock current dynamic parameter adjustment1; <b>unit:0.01mA</b>	1~65535 (Read and Write)	38
0x0186	Closed loop lock current Dynamic adjustment parameters2	Closed-loop lock current dynamic parameter adjustment2; <b>unit:0.01mA</b>	1~65535 (Read and Write)	38
0x0187	Open and closed loop alarm detection Enable	Open and closed loop alarm detection enable control: 0: Disable the corresponding alarm function; 1: Enable the corresponding alarm function; The following is the correspondingBitBit control function: Bit0: Overcurrent alarm (reserved); Bit1: Over-voltage and under-voltage alarm; Bit2~Bit3:reserve; Bit4: Phase loss alarm; Bit5:reserve; Bit6: Timeout alarm when returning to origin; Bit7: Out-of-tolerance alarm; Bit8~Bit15:reserve;	0~65535 (Read and Write)	255
0x0188	Stall return to zero error limit	Set the stall return zero error limit value; <b>unit:1represent0.09°</b>	1~65535 (Read and Write)	500
0x0189	Closed-loop locking machine positioning accuracy Threshold2	Set the positioning accuracy threshold of the closed-loop locking machine2; <b>unit:0.1Encoder value</b>	0~65535 (Read and Write)	25
0x018A	Closed-loop lock integral enable	Closed-loop lock state, integral enabled; 0: Disable; 1: enable;	0~1	0
0x018B	Closed-loop locking machine integral limit Adjustment	Closed-loop lock machine integral limit percentage adjustment; <b>unit:%</b>	0~1000	100
0x018C	Closed loop locking methodBelectricity Flow Percentage Throttling	Closed loop power-on lock modeBCurrent percentage; <b>unit:%</b>	0~500 (Read and Write)	100
0x018D	reserve;			
0x018E	Phase storage time	Phase memory storage time; <b>unit:ms</b>	500~65535	1000
0x018F	Mechanical transmission ratio	For stepper motors with reducers; Mechanical transmission ratio = reduction box gear/motor gear; high8Position: represents the gear of the reduction box;	0x0101~0x3232	0x0101

		<p>Low8Bit: represents the motor gear;</p> <p>For example: If10If the reducer has a ratio of for0x010A;</p> <p>Note that if the mechanical transmission ratio is not1, then set The parameters of the position and speed related registers are actually The corresponding position and speed are output after the reducer.</p> <p>Value (already converted within the program);</p> <p><b>Note:</b>After modification, save the parameters and restart the power to make them effective;</p>		
--	--	--	--	--

4.2.12 Brake control parameter group (read and write)

surface4.13 Brake control parameter group register

Register Address	project	illustrate	Setting range <small>Note: Other values are invalid.</small>	default value
Brake control parameter group				
0x0190~ 0x0193		reserve;		

4.2.13 Status, fault code parameter group (read only)

surface4.14 Status and fault code parameter group register

Register Address	project	illustrate	Setting range Note: Other values are invalid.	default value
Status and fault code parameter group (shared by open and closed loop)				
0x0194	The most recent fault code	Err0x01: Overcurrent (reserved); <b>SubErr:0x10;</b>	(read only)	
0x0195	The most recent fault code Subcode	Err0x02: Over-voltage or under-voltage; <b>SubErr:0x20: Overpressure alarm;</b> 0x21: Undervoltage alarm;	(read only)	
0x0196	The most recent two fault codes	Err0x03: Over-travel alarm; <b>SubErr:0x30: Positive hard limit overtravel;</b> 0x31: Reverse hard limit overtravel;	(read only)	
0x0197	The most recent two fault codes Subcode	0x32: Forward soft limit overtravel; 0x33: Reverse soft limit overtravel;	(read only)	
0x0198	The last three fault codes	Err0x04:EEPROMRead and write errors; <b>SubErr:0x41: Read error;</b> 0x42: Write error;	(read only)	
0x0199	The last three fault codes Subcode	Err0x05: Communication error; <b>SubErr:0x51: CRCVerification error;</b> 0x52: Function code error; 0x53: Error in reading illegal data address; 0x54: The write data address is out of range; 0x55: Read register number overflow (maximum <b>One read16registers);</b> 0x56: Illegal reading and writing of function code; 0x57: The data written into the register exceeds the limit; Err0x06: Phase loss alarm; <b>SubErr:0x60:A,BAll lack phase alarm;</b> 0x61:Aphase lacks phase; 0x62:Bphase lacks phase; Err0x07: Out-of-tolerance alarm; <b>SubErr:0x70: Normal out-of-tolerance alarm;</b> 0x71: Out-of-tolerance alarm caused by overvoltage; 0x72: Out-of-tolerance alarm caused by undervoltage; Err0x08: Timeout alarm when returning to origin; <b>SubErr:0x80;</b> Err0x09: Restore factory settings/save parameters; <b>SubErr:0x90: Restore factory settings;</b> 0x91:reserve;	(read only)	-

		<p>0x92: Save common parameter groups1;</p> <p>0x93: Save the common open-loop parameter group;</p> <p>0x94: Save the common closed-loop parameter group;</p> <p>0x95: Save basic control parameter group1;</p> <p>0x96: Save the back-to-origin parameter group;</p> <p>0x97: Save basic control parameter group2;</p> <p>0x98: Save common parameter groups2;</p> <p>0x99: Save multi-segment mode parameter group;</p> <p>0x9A: Save the performance parameter group;</p> <p>0x9B: Save the brake parameter group;</p> <p>0x9C: Save fault code parameter group;</p> <p>0x9D: Save the input and output parameter groups;</p> <p>0x9E: Save user parameter group;</p> <p>0x9F: Save all parameter groups;</p> <p>Err0x0A: Alarm for unreasonable speed parameter settings;</p> <p><b>SubErr:0xA0:Vmax&gt;Vmin;</b></p>		
0x019A	Communication fault information	<p>Bit0:EEPROMRead error;</p> <p>Bit1:EEPROMWrite error;</p> <p>Bit2:CRCVerification error;</p> <p>Bit3: Function code error;</p> <p>Bit4: Error in reading illegal data address;</p> <p>Bit5: The write data address is out of range;</p> <p>Bit6: The number of registers read overflows (at most one read16 registers);</p> <p>Bit7: Illegal reading and writing of function code;</p> <p>Bit8: The data written into the register exceeds the limit;</p> <p>Bit9: Communication errors caused by executing the save command;</p> <p>When saving is completed, this bit is automatically cleared;</p> <p>Bit10: Communication errors caused by restoring factory settings;</p> <p>When the factory reset is complete, this bit is automatically cleared;</p> <p>Bit11~Bit15:reserve;</p>	(read only)	-
0x019B	reserve;			
0x019C	Drive fault information Low16Bit	<p>Bit0: Overcurrent;</p> <p>Bit1: Overpressure;</p> <p>Bit2: Undervoltage;</p>	(read only)	-
0x019D	Drive fault information high16Bit	<p>Bit3: Positive hard limit overtravel;</p> <p>Bit4: Reverse hard limit overtravel;</p> <p>Bit5: Forward soft limit overtravel;</p> <p>Bit6: Reverse soft limit overtravel;</p> <p>Bit7:A,BAll lack phase;</p>		



		<p>Bit8:Aphase lacks phase;</p> <p>Bit9:Bphase lacks phase;</p> <p>Bit10: Normal to abnormal;</p> <p>Bit11: Excessive tolerance caused by overvoltage;</p> <p>Bit12: Excessive tolerance caused by undervoltage;</p> <p>Bit13: Return to origin timeout;</p> <p>Bit14: Speed setting <math>V_{max} &gt; V_{min}</math>;</p> <p>Bit15~Bit31:reserve;</p>		
0x019E	<p>Closed-loop positioning accuracy value</p> <p>Low16Bit</p>	<p>Closed-loop positioning accuracy value (the highest bit represents the sign bit);</p> <p>Accuracy = target position - actual position;</p> <p>A positive value indicates that the target position has not been reached and the current running direction is</p>	- 2147483648~	-
0x019F	<p>Closed-loop positioning accuracy value</p> <p>high16Bit</p>	<p>A negative value means that the position is exceeded.</p> <p>The target position is offset by a certain position toward the current running direction;</p> <p>Unit: Base10, 1 represent 0.1 encoder values;</p>	2147483647	-
0x01A0	<p>Single run time</p> <p>Low16Bit</p>	<p>You can query the time it takes for the motor to start and stop once;</p>	(read only)	-
0x01A1	<p>Single run time</p> <p>high16Bit</p>	unit:us		
0x01A2	<p>Actual in position mode</p> <p>Given starting speed</p>	unit:rev/min	(read only)	-
0x01A3	<p>Actual in position mode</p> <p>Given acceleration time</p>	unit:ms	(read only)	-
0x01A4	<p>Actual in position mode</p> <p>Given deceleration time</p>	unit:ms	(read only)	-
0x01A5	<p>Actual in position mode</p> <p>Given maximum speed</p>	unit:rev/min	(read only)	-
0x01A6	<p>Forward and reverse direction encoder</p> <p>Total difference low16Bit</p>	<p>In closed loop mode (positive and negative):</p> <p>If the difference is positive, it means the encoder is receiving in the positive direction.</p> <p>The total number of values is greater than the total number of encoder values received in the reverse direction;</p>	- 2147483648~	-
0x01A7	<p>Forward and reverse direction encoder</p> <p>Total difference high16Bit</p>	<p>If the difference is negative, it means that the encoder is receiving in the opposite direction.</p> <p>The total number of values is greater than the total number of encoder values received in the positive direction;</p>	2147483647	-
0x01A8~ 0x01AF	reserve;			

4.2.14 User parameter group (read and write)

surface4.15 User Parameter Group Registers

Register Address	project	illustrate	Setting range <small>Note: Other values are invalid.</small>	default value
User parameter group register (shared by open and closed loop)				
0x01D0~ 0x01EF	reserve;			

### 4.3 MODBUS Common function codes

#### 4.3.1 Read Holding Register Command 0x03

(1) The command to read a single register is as follows:

##### Master->Slave data:

illustrate	Device Address	Function code	Register Address	Read register number	CRCcheck
Message	01	03	00 33	00 01	74 05
explain	The master sends a query to the slave for the maximum speed (0x0033) Register instruction				

##### Slave->Master data:

illustrate	Device Address	Function code	Returns the number of bytes	Register Value	CRCcheck
Message	01	03	02	03 E8	74 05
explain	Slave returns data: Maximum speed 1000rev/min				

(2) The commands to read multiple registers are as follows:

##### Master->Slave data:

illustrate	Device Address	Function code	Register Address	Read register number	CRCcheck
Message	01	03	00 30	00 04	44 06
explain	The host asks the slave for the starting speed (0x0030) Start4 Register value				

##### Slave->Master data:

illustrate	Device Address	Function code	Returns the number of bytes	Register Value	CRCcheck
Message	01	03	08	00 05 00 64 00 64 03 E8	F0 7E
explain	Slave returns data: start speed 5rev/min, acceleration time 100ms, deceleration time 100ms, Maximum speed 1000rev/min				

Note: The maximum number of queries cannot exceed 16 registers.

#### 4.3.2 Write Single Register Command 0x06

(1) Write the set value to the register

##### Master->Slave data:

illustrate	Device Address	Function code	Register Address	Writing Data	CRCcheck
Message	01	06	00 30	01 2C	89 88
explain	Master to slave's starting speed (0x0030) Register write value 300				

##### Slave->Master data:

illustrate	Device Address	Function code	Register Address	Writing Data	CRCcheck
Message	01	06	00 30	01 2C	89 88
explain	After receiving the command, the slave returns the same command for confirmation				

**4.3 Write multiple registers command 0x10**

**Master->Slave data:**

illustrate	Device Address	Function code	Starting address	Write Register Number of devices	Total bytes	Writing Data 1	Writing Data 2	CRCschool Test
Message	01	10	00 30	00 02	04	01 2C	03 E8	30 30
explain	The host writes two registers to the slave to set the starting speed (0x0030)' and 'acceleration time (0x0031)' register							

**Slave->Master data:**

illustrate	Device Address	Function code	Starting address	Write register number	CRCcheck
Message	01	10	00 30	00 02	41 C7
explain	After receiving this instruction, the slave returns the number of registers written for confirmation				

**4.4 Communication error code**

485seriesMODBUSThe communication abnormality code table is as follows:

surface4.11 MODBUSException code

Exception code	name	meaning
01	CRCVerification Error	CRCVerification error.
02	Function code sending error	The slave receives0x03,0x06,0x10Function codes other than .
03	Error reading illegal data address	The data address requested to be read does not exist in the slave.
04	Write data address exceeds Address range	The register address to which data is written exceeds the register address definition range.
05	Read register count overflow	At most once read16data of an address.
06	Function code illegal read and write data error	Function code read and write attributes are divided into three types: read-only, write-only, and read-write. Abnormal data operation error.
07	The data written into the register exceeds the limit	The data content written to the register exceeds its specified range.

**4.4.1 CRCVerification Error**

As shown in the following table, if the host sends a frame read data command, and an error occurs during the data transmission, the slave device calculates the frame number.

According to the obtainedCRCThe check value is not85 C1, the slave returns an exception code01.

**Master->Slave data:**

illustrate	Device Address	Function code	Register Address	Read register number	CRCcheck
Message	01	03	00 20	00 01	85 C1

**Slave->Master data:**

illustrate	Device Address	Function code+0x80	Exception code	CRCcheck
Message	01	83	01	80 F0

**4.4.2Function code sending error**

As shown in the following table, if the function code requested by the host is not 0x03, 0x06 and 0x10, the slave returns an exception code 02.

**Master->Slave data:**

illustrate	Device Address	Function code	Register Address	Read register number	CRCcheck
Message	01	02	00 00	00 04	79 C9

**Slave->Master data:**

illustrate	Device Address	Function code+0x80	Exception code	CRCcheck
Message	01	82	02	61 C1

**4.4.3Error reading illegal data address**

As shown in the following table, if the data address requested by the host is illegal, that is, it does not exist, the slave returns an exception code 03.

**Master->Slave data:**

illustrate	Device Address	Function code	Register Address	Read register number	CRCcheck
Message	01	03	00 FF	00 01	B4 3A

**Slave->Master data:**

illustrate	Device Address	Function code+0x80	Exception code	CRCcheck
Message	01	83	03	01 31

**4.4.4The write data address exceeds the address range**

As shown in the following table, if the register address to which the host writes data exceeds the defined range, the slave returns an exception code 04.

**Master->Slave data:**

illustrate	Device Address	Function code	Register Address	Writing Data	CRCcheck
Message	01	06	FF 00	0B 00	BE FE

**Slave->Master data:**

illustrate	Device Address	Function code+0x80	Exception code	CRCcheck
Message	01	86	04	43 A3

#### 4.4.5 Read register count overflow

As shown in the following table, if the number of registers requested by the host exceeds the maximum range of one read, the slave returns an exception code 05.

##### Master->Slave data:

illustrate	Device Address	Function code	Register Address	Read register number	CRCcheck
Message	01	03	00 20	00 20	45 D8

Read once 32. The data of the address exceeds the set range and returns an exception code 05.

##### Slave->Master data:

illustrate	Device Address	Function code+0x80	Exception code	CRCcheck
Message	01	83	05	81 33

#### 4.4.6 Function code illegal read and write data error

As shown in the following table, the function code read and write attributes are divided into three types: read-only, write-only, and read-write. For register operations that do not conform to the function code attributes,

The machine returns an exception code 06.

##### Master->Slave data:

illustrate	Device Address	Function code	Register Address	Read register number	CRCcheck
Message	01	03	00 27	00 01	34 01

Assume register 0x0027. It is a write-only address. If you perform a read operation on it, an exception code will be reported. 06.

##### Slave->Master data:

illustrate	Device Address	Function code+0x80	Exception code	CRCcheck
Message	01	83	06	C1 32

#### 4.4.7 The data written into the register exceeds the limit

As shown in the following table, if the data content written to the register exceeds its specified range, the slave returns an exception code 07.

##### Master->Slave data:

illustrate	Device Address	Function code	Register Address	Writing Data	CRCcheck
Message	01	06	00 30	C3 50	D9 09

##### Slave->Master data:

illustrate	Device Address	Function code+0x80	Exception code	CRCcheck
Message	01	86	07	03 A2

**4.5 Application Examples**

**4.5.1 Position Mode Operation Setting Example**

The position mode includes relative position and absolute position. After the corresponding parameters are set by the host computer, the motor runs at a certain angle.

For example, setting the drive1The operating parameters in open-loop mode are: effective current2000mA, Segment1000Pul/rev, starting speed10r/min,

Acceleration time100ms, deceleration time100ms, Maximum speed300r/min, forward rotation1circle and start running in relative position mode.

**Notice:**

(1) Before communication, it is necessary to confirm whether the communication baud rate and serial port data format of the master and slave stations are consistent;

(1) Before setting the parameters, you need toSW1-SW4Set tooff off off offoron off off off, make sure the drive address is1;

(2)like485The drive is closed-loop by default, and the open-loop mode can be set through the register0x001Cset up;

(3) The following steps1-9There is no particular order for the settings.10The previous settings are completed, and then the motor can be started;

(4) In this example, the steps3-8The setting adopts the 'write single register' command, and can also be set by 'write multiple registers command'.

For specific command setting rules, please refer to4.3.3subsection;

The specific setting steps are as follows:

step	Function settings	Data transmission direction	instruction
1	Set the effective current to2000mA	Master->Slave	01 06 00 1E 07 D0 EA 60
		Slave->Master	01 06 00 1E 07 D0 EA 60
2	Set the subdivisions to1000Pul/rev	Master->Slave	01 06 00 1F 03 E8 B8 B2
		Slave->Master	01 06 00 1F 03 E8 B8 B2
3	Set the starting speed to10 r/min	Master->Slave	01 06 00 30 00 0A 09 C2
		Slave->Master	01 06 00 30 00 0A 09 C2
4	Set the acceleration time to100ms	Master->Slave	01 06 00 31 00 64 D9 EE
		Slave->Master	01 06 00 31 00 64 D9 EE
5	Set the deceleration time to100ms	Master->Slave	01 06 00 32 00 64 29 EE
		Slave->Master	01 06 00 32 00 64 29 EE
6	Set the maximum speed to 300 r/min	Master->Slave	01 06 00 33 01 2C 79 88
		Slave->Master	01 06 00 33 01 2C 79 88
7	Set the total pulse number low bit to1000	Master->Slave	01 06 00 34 03 E8 C8 BA
		Slave->Master	01 06 00 34 03 E8 C8 BA

8	Set the total pulse count high bit to 0	Master->Slave	01 06 00 35 00 00 99 C4
		Slave->Master	01 06 00 35 00 00 99 C4
9	Send an enable command to lock the motor	Master->Slave	01 06 00 39 00 01 98 07
		Slave->Master	01 06 00 39 00 01 98 07
10	Speed mode start command	Master->Slave	01 06 00 37 00 01 F9 C4
		Slave->Master	01 06 00 37 00 01 F9 C4

#### 4.5.2 Speed Mode Operation Setting Example

In speed mode, after the corresponding parameters are set by the host computer, the motor will maintain the set speed and run at a constant speed.

The operating parameters in open-loop mode are: effective current 2000mA, Segment 1000Pul/rev, starting speed 10r/min, acceleration time 100ms,

Deceleration time 100ms, Maximum speed 300r/min, and then maintain a constant speed.

##### Precautions before operation:

(1) Before communication, it is necessary to confirm whether the communication baud rate and serial port data format of the master and slave stations are consistent;

(2) Before setting the parameters, you need to SW1-SW4 Set to off, make sure the drive address is 1;

(3) The drive is closed-loop by default, and the open-loop mode can be set through the register 0x001C set up;

(4) The following steps 1-7 There is no particular order for the settings. The previous settings are completed, and then the motor can be started;

(5) In this example, the steps 3-6 The setting adopts the 'write single register' command, and can also be set by 'write multiple registers command'.

For specific command setting rules, please refer to 4.3.3 subsection;

##### The specific setting steps are as follows:

step	Function settings	Data transmission direction	instruction
1	Set the effective current to 2000mA	Master->Slave	01 06 00 1E 07 D0 EA 60
		Slave->Master	01 06 00 1E 07 D0 EA 60
2	Set the subdivisions to 1000Pul/rev	Master->Slave	01 06 00 1F 03 E8 B8 B2
		Slave->Master	01 06 00 1F 03 E8 B8 B2
3	Set the starting speed to 10 r/min	Master->Slave	01 06 00 30 00 0A 09 C2
		Slave->Master	01 06 00 30 00 0A 09 C2
4	Set the acceleration time to 100ms	Master->Slave	01 06 00 31 00 64 D9 EE
		Slave->Master	01 06 00 31 00 64 D9 EE
5	Set the deceleration time to 100ms	Master->Slave	01 06 00 32 00 64 29 EE



		Slave->Master	01 06 00 32 00 64 29 EE
6	Set the maximum speed to 300 r/min	Master->Slave	01 06 00 33 01 2C 79 88
		Slave->Master	01 06 00 33 01 2C 79 88
7	Send an enable command to lock the motor	Master->Slave	01 06 00 39 00 01 98 07
		Slave->Master	01 06 00 39 00 01 98 07
8	Speed mode start command	Master->Slave	01 06 00 37 00 01 F9 C4
		Slave->Master	01 06 00 37 00 01 F9 C4

## 5. Introduction to Motion Control Function

### 5.1 Position Mode

Position mode includes relative position and absolute position. Relative position takes the current static point as the starting point, and absolute position takes the current static point as the starting point.

The position after reset or homing is the starting point. The 'start command' register can be used to control whether it is relative position movement or absolute position movement.

For reference 4.2.5 and 5.5 chapter.

In position mode, after the corresponding parameters are set by the host computer, the motor runs at a certain angle. The running process adopts trapezoidal acceleration and deceleration.

Now, users can set the starting speed, maximum speed, acceleration time, deceleration time, and total pulse number through the host computer to achieve accurate

Position control. The trapezoidal acceleration and deceleration curve is shown in the figure 5.1 shown.

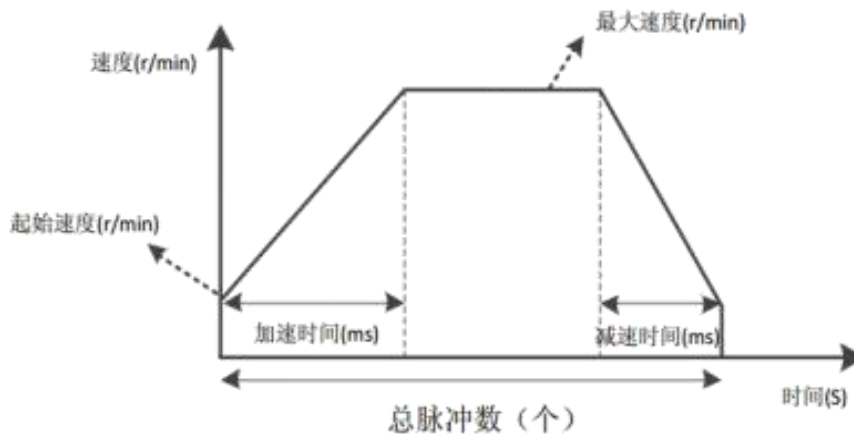

picture5.1Trajectory of normal operation of position mode

Please note that in relative position mode, the direction of the motor is determined by setting the positive or negative of the total pulse number. The total pulse number is usually defined as positive.

When the value is set, the motor rotates forward, otherwise, the motor rotates reversely. In absolute position mode, the initial direction of the motor is positive or negative with the set total pulse number.

After the pulse is turned off, the subsequent running direction will also be related to the total number of pulses set.

When the total number of pulses set by the user is small, the motor may need to decelerate before accelerating to the maximum speed.

As shown in the figure, the solid line shows the actual running track of the motor, and the dotted line shows the track required to accelerate to the set maximum speed.

The number of pulses is the theoretical minimum total number of pulses calculated according to the user-set parameters: starting speed, maximum speed, acceleration time, and deceleration time.

When the total pulse number set by the user is less than the theoretical minimum total pulse number, the motor will run along the solid line.

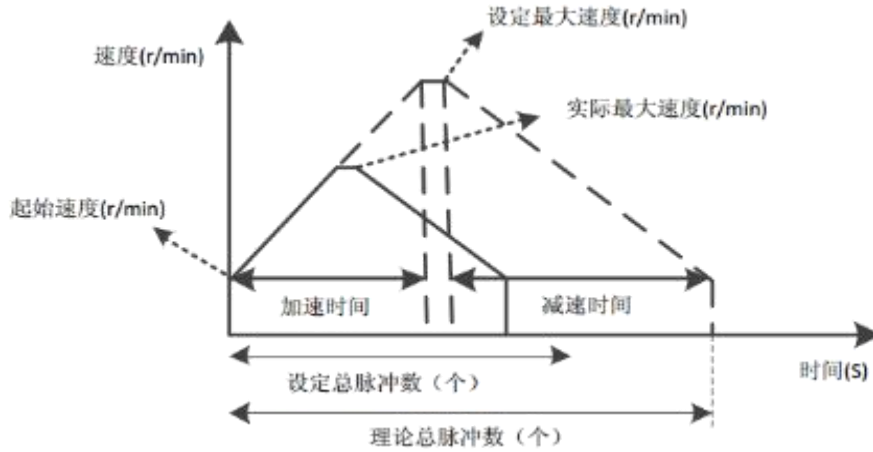

picture5.2Position mode sets the running trajectory with a smaller total pulse number

## 5.2Speed Mode

Speed mode means that the motor keeps running at a constant speed at the set speed. Different from position mode, the user only needs to set the starting speed, the maximum speed and the

The motor accelerates to the maximum speed according to the set parameters and keeps running at a constant speed.

The direction of the motor is determined by setting the maximum speed to a positive or negative value. Usually, when the maximum speed is positive, the motor rotates forward, and vice versa.

Reverse. The acceleration curve of speed mode is shown in the figure5.3shown.

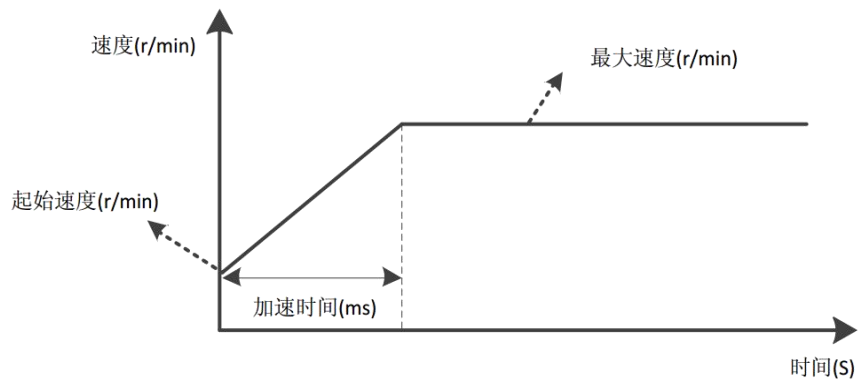

picture5.3Speed mode acceleration curve

### 5.3 Return to origin mode

IRS35(E) All-in-one 485 bus-type stepper driver currently supports the following return to zero methods: 3(-6), 17-30, 33-35, 37-39, these Mode requires the use of limits, origin or ZSignal.

Before configuring the homing mode, you need to configure the input port function to origin, positive limit or negative limit. 17-18 for 2 kind Limit return to zero mode, mode 19-22 for 4 Ways to return to zero point: 23-26 for 4 Origin + positive limit return to zero mode, mode 27-30 for 4 The origin + negative limit return to zero method, 33-34 for 2 kind ZSignal return to zero mode, 35, 37 To use the current as zero point, 38-39 Return to zero position model, (-3) (-4) It is the stall return to zero mode in closed loop mode.

The start of the homing mode can be triggered by sending a 'start command' from the host computer, or by using an external I/O signal. The signal is used as a trigger source to start returning to the origin function, but the function of a certain input port needs to be configured as the "home enable signal" function. Before this, you can use the register 0x003B-0x0041 Configure the homing mode, homing speed, homing acceleration/deceleration time, and homing compensation value.

Apply and select the appropriate homing mode. The following sections briefly introduce the path processes of several homing modes.

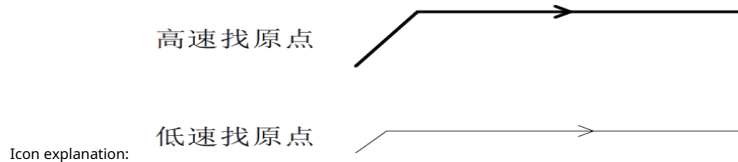

**Note:** In the following schematic diagrams defining all return-to-zero methods, movement to the right is positive movement, and movement to the left is negative movement.

#### 5.3.1 Way(-3)(Stalled return to zero1)

The motor initially returns to the origin speed V1. Running in the forward direction, after a stall occurs, the motor decelerates to stop and moves in the reverse direction. After the motor dynamic torque disappears, Decelerate to a stop and use this position as the origin.

The entire action of this zero return method is shown in the figure below. No detailed description is given here.

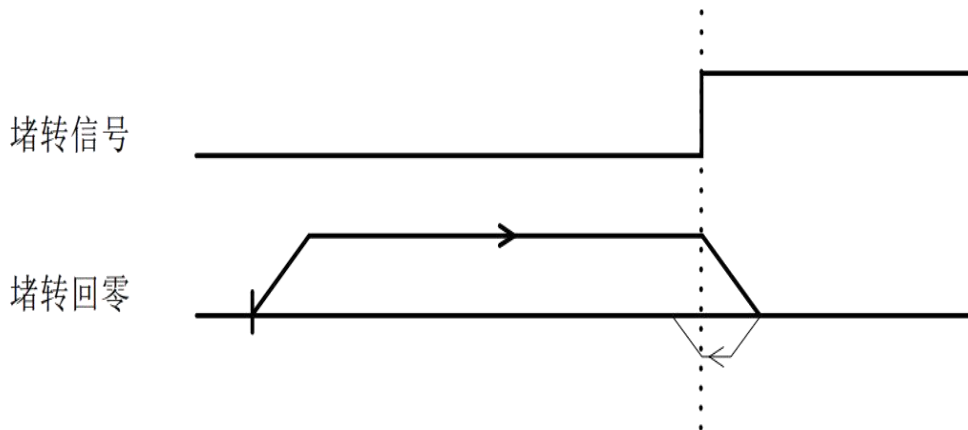

### 5.3.2Way(-4)(Stalled return to zero2)

The motor initially returns to the origin speedV1'Running in the opposite direction, after a stall occurs, it decelerates to stop and moves in the opposite direction. After the dynamic torque of the motor disappears,

Decelerate to a stop and use this position as the origin.

The entire action of this zero return method is shown in the figure below. No detailed description is given here.

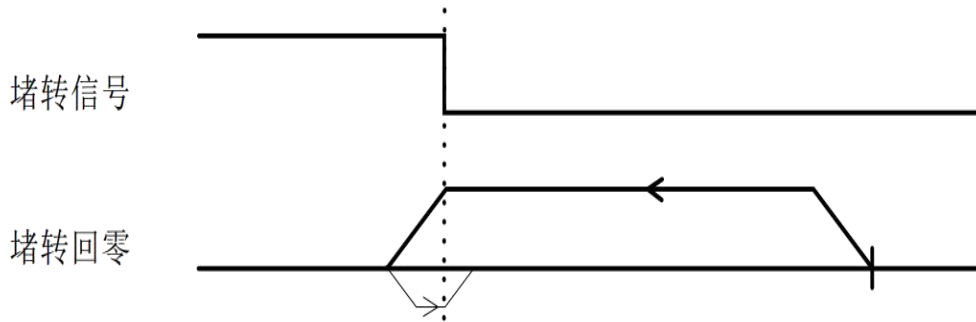

### 5.3.3Way(-5)(Stalled return to zero3)

The motor initially returns to the origin speedV1'When running in the positive direction and a stall occurs, the machine stops immediately and takes this position as the origin.

The entire action of this zero return method is shown in the figure below. No detailed description is given here.

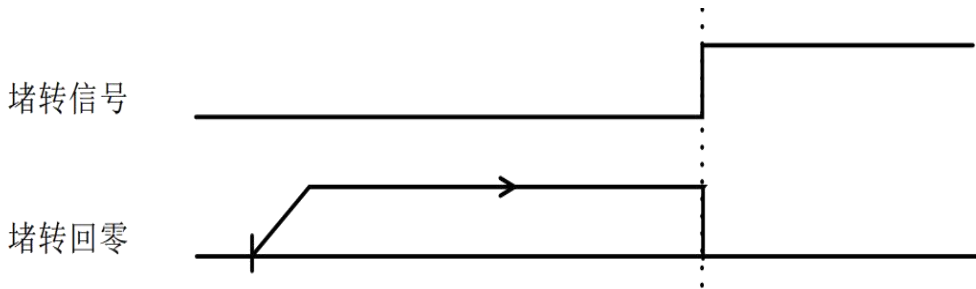

### 5.3.4Way(-6)(Stalled return to zero4)

The motor initially returns to the origin speedV1'If the machine runs in the reverse direction and a stall occurs, it stops immediately and takes that position as the origin.

The entire action of this zero return method is shown in the figure below. No detailed description is given here.

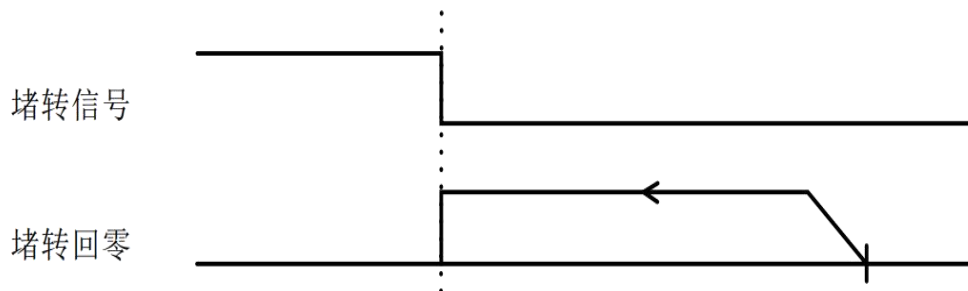

### 5.3.5Way17(Negative limit return to zero)

The origin stop position of 'Negative limit return to zero' is at the negative limit signal.

The whole action of 'negative limit return to zero' is divided into two cases, as follows:

ConditionA: After the drive receives the 'home enable signal' command, it will start at the 'home speedV1', 'Return to origin acceleration and deceleration time' several parameters open

Starts to move, and when encounters the rising edge of the limit signal, it decelerates and stops. Then it returns to the origin speedV2'Run in the opposite direction until the limit signal is met.

At the falling edge, deceleration stops and the entire return to zero action is completed.

ConditionB: After receiving the 'Home Enable Signal' command, the drive is within the limit and willV2', 'Return to the original

Click the 'acceleration/deceleration time' parameter to start the movement. When the falling edge of the limit signal is encountered, the movement will be decelerated and stopped, and the whole return to zero action is completed.

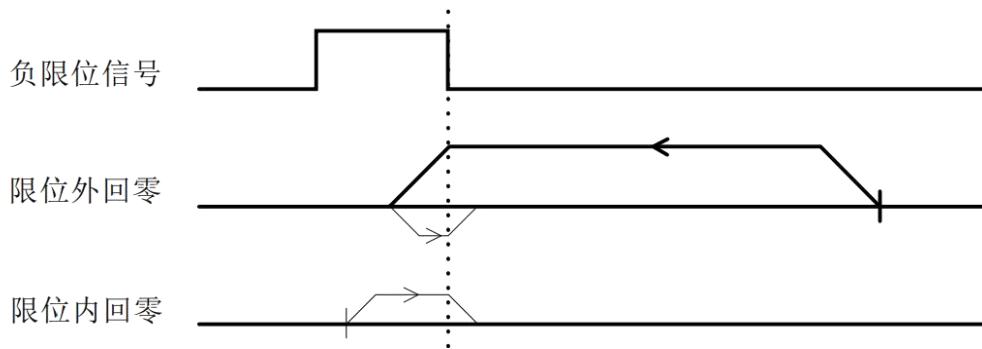

### 5.3.6Way18(Positive limit return to zero)

The origin stop position of 'Positive limit return to zero' is at the positive limit signal.

'Positive limit return to zero' is similar to 'Negative limit return to zero', except that the running direction is opposite, so it will not be explained in detail here.

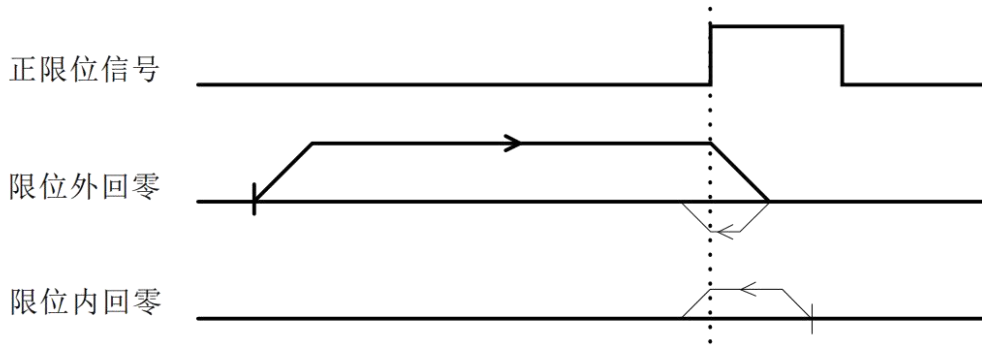

### 5.3.7Way19(Return to zero1)

'Return to zero1' The origin stop position is on the left side of the rising edge of the origin signal in the positive direction.

'Return to zero1' The whole action is divided into two cases, as follows:

ConditionA: After the drive receives the 'home enable signal' command, it will start at the 'home speedV1', 'Return to origin acceleration and deceleration time' and other parameters

Move in the positive direction, and when it encounters the rising edge of the origin signal, it decelerates and stops. Then it returns to the origin speedV2'Run in the opposite direction until it encounters the origin signal

When the signal falls, the deceleration stops and the whole return to zero action is completed.

ConditionB: After receiving the 'home enable signal' command, the drive is in the home signal, and willV2', 'Back

The origin acceleration/deceleration time and several parameters move in the opposite direction. When the origin signal falls, the deceleration stops and the whole return to zero action is completed.

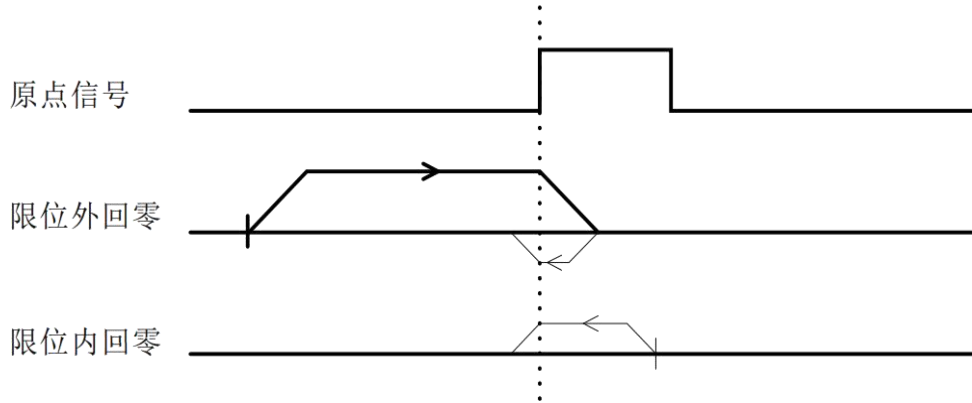

### 5.3.8Way20(Return to zero2)

'Return to zero2'The origin stop position is on the right side of the rising edge of the origin signal in the positive direction.

'Return to zero2'The whole action is shown in the figure below. No detailed description is given here.

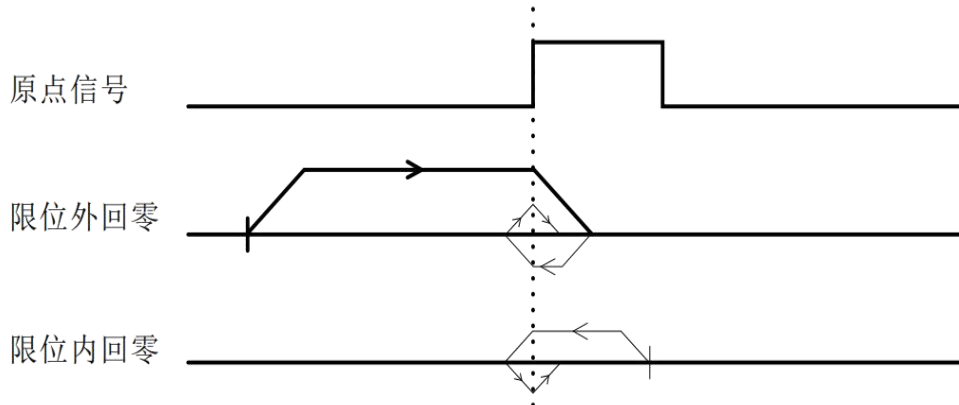

### 5.3.9Waytwenty one(Return to zero3)

'Return to zero3'The origin stop position is on the right side of the rising edge of the origin signal in the reverse direction.

'Return to zero3'The whole action is similar to 'return to zero1'The difference is that the initial running direction is opposite. No detailed description will be given here.

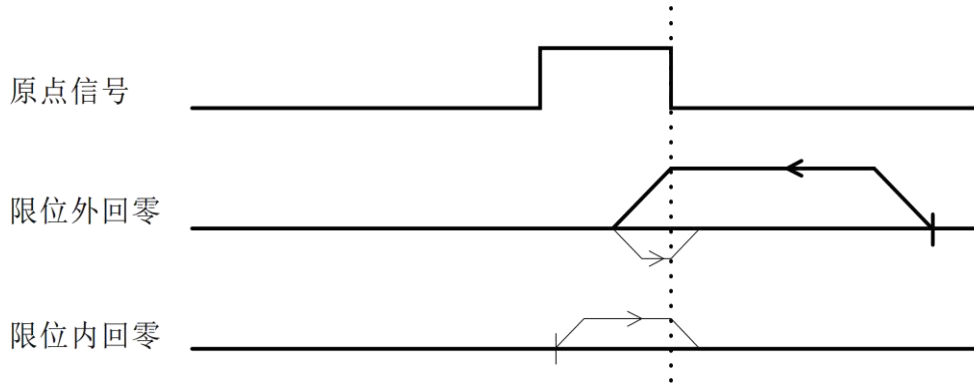

**5.3.10Waytwenty two(Return to zero4)**

'Return to zero4'The origin stop position is on the left side of the rising edge of the origin signal in the reverse direction.

'Return to zero4'The whole action is similar to 'return to zero2'The difference is that the initial running direction is opposite. No detailed description will be given here.

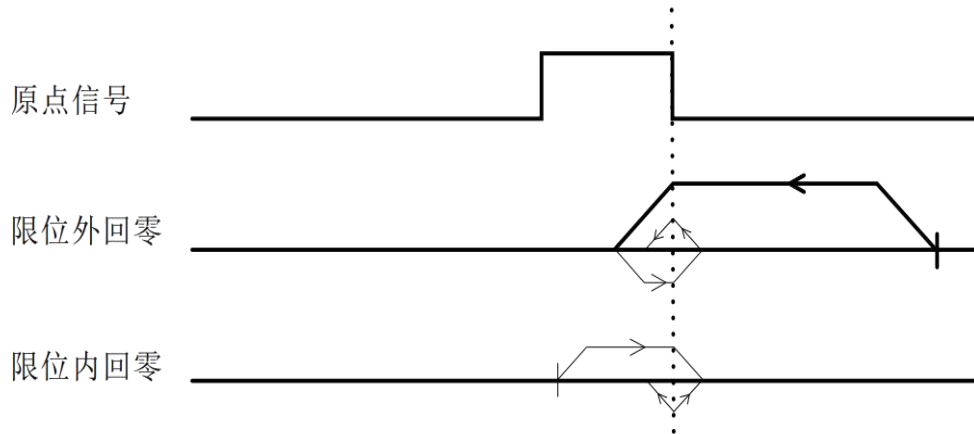

**5.3.11Waytwenty three(Origin + positive limit return to zero1)**

'Origin + positive limit return to zero1'The origin stop position is on the left side of the rising edge of the origin signal in the positive direction.

'Origin + positive limit return to zero1'The whole action is divided into three cases, as follows:

ConditionA: After the drive receives the 'home enable signal' command, it will start at the 'home speedV1', 'Return to origin acceleration and deceleration time' and other parameters

Move in the positive direction, and when it encounters the rising edge of the origin signal, it decelerates and stops. Then it returns to the origin speedV2'Run in the opposite direction until it encounters the origin signal

When the signal falls, the deceleration stops and the whole return to zero action is completed.

ConditionB: After the drive receives the 'home enable signal' command, it will start at the 'home speedV1', 'Return to origin acceleration and deceleration time' and other parameters

Move in the positive direction, and stop immediately when encountering the rising edge of the positive limit signal. Then return to the origin at the speedV2'Run in the opposite direction until you reach the origin

When the signal falls, the deceleration stops and the entire return to zero action is completed.

ConditionC: After receiving the 'home enable signal' command, the drive is in the home signal, and willV2', 'Back

The origin acceleration/deceleration time and several parameters move in the opposite direction. When the origin signal falls, the deceleration stops and the whole return to zero action is completed.



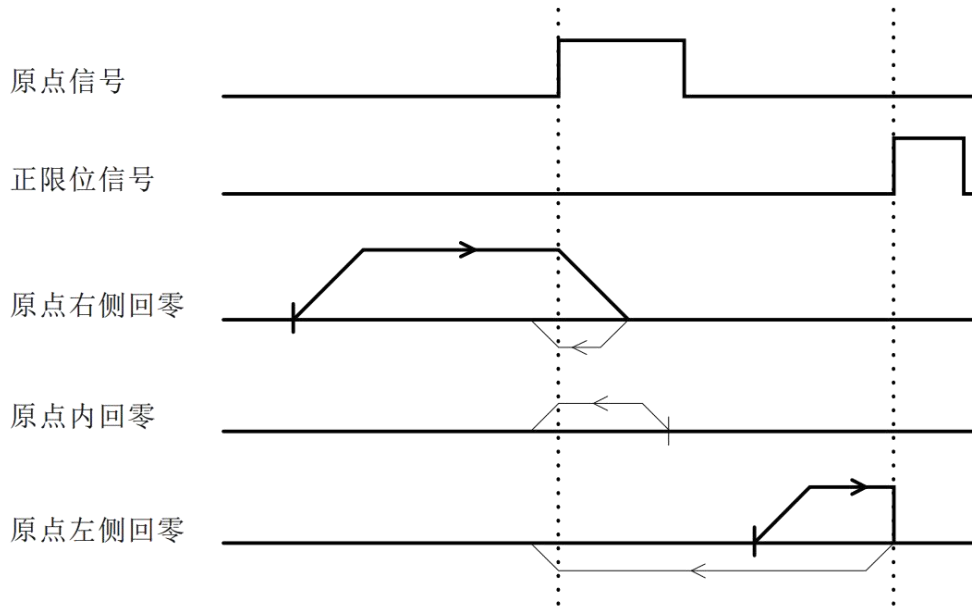

**5.3.12Waytwenty four(Origin + positive limit return to zero2)**

'Origin + positive limit return to zero2'The origin stop position is on the right side of the rising edge of the origin signal in the positive direction.

'Origin + positive limit return to zero2'The whole action is shown in the figure below. No detailed description is given here.

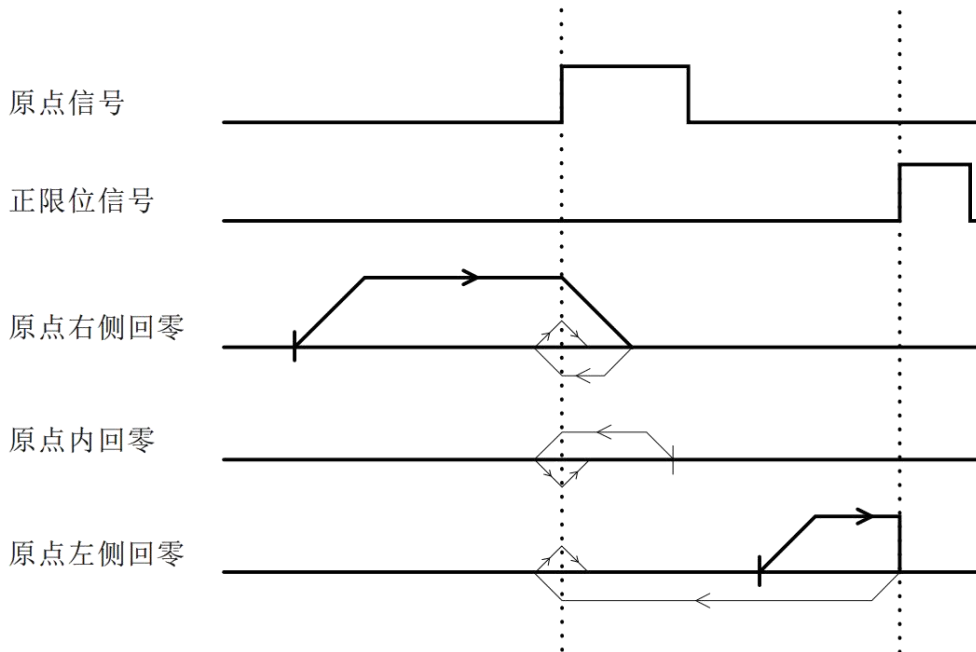

**5.3.13Way25(Origin + positive limit return to zero3)**

'Origin + positive limit return to zero3'The origin stop position is on the left side of the falling edge of the origin signal in the positive direction.

'Origin + positive limit return to zero1'The whole action is divided into three cases, as follows:

ConditionA: After the drive receives the 'home enable signal' command, it will start at the 'home speedV1', 'Return to origin acceleration and deceleration time' and other parameters

Move in the positive direction. When the origin signal rises, the machine continues to run. When the origin signal falls, the machine slows down and stops. Then the machine returns to the original position.

Origin speedV2'It runs in the opposite direction until it encounters the rising edge of the origin signal, then decelerates and stops, and the entire return to zero action is completed.

ConditionB: After the drive receives the 'home enable signal' command, it will start at the 'home speedV1', 'Return to origin acceleration and deceleration time' and other parameters

Move in the positive direction, and stop immediately when encountering the rising edge of the positive limit signal. Then return to the origin at the speedV2'Run in the opposite direction until you reach the origin

When the signal rises, the deceleration stops and the entire return to zero action is completed.

ConditionC: After receiving the 'home enable signal' command, the drive is in the home signal, and willV1', 'Back

The origin acceleration and deceleration time's several parameters move in the positive direction, and when the origin signal falls, it decelerates and stops. Then it returns to the origin speedV2'

It runs in the opposite direction until it encounters the rising edge of the origin signal, then decelerates and stops, and the entire return to zero action is completed.

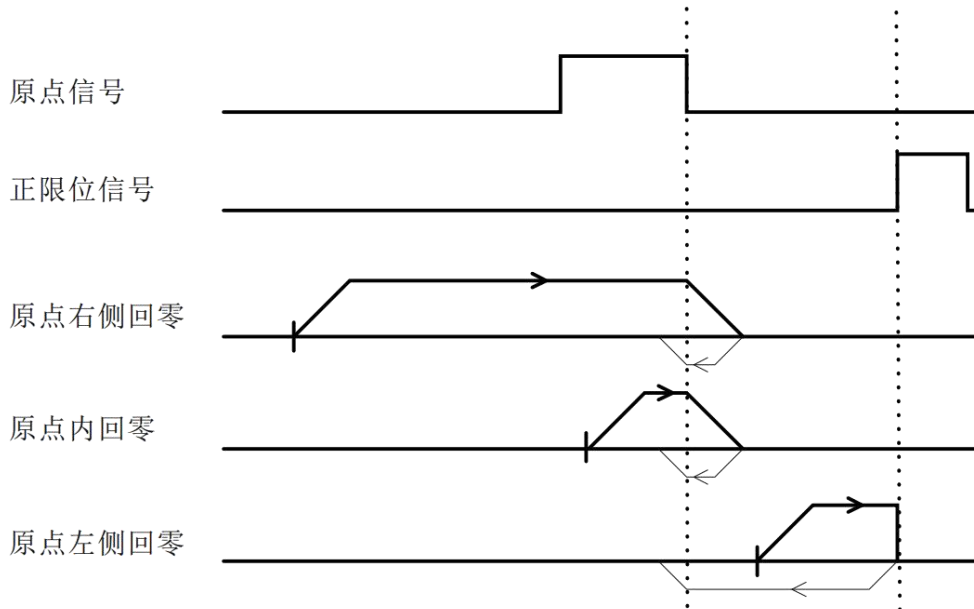

5.3.14Way26(Origin + positive limit return to zero4)

'Origin + positive limit return to zero4'The origin stop position is on the right side of the falling edge of the origin signal in the positive direction.

'Origin + positive limit return to zero4'The whole action is shown in the figure below. No detailed description is given here.

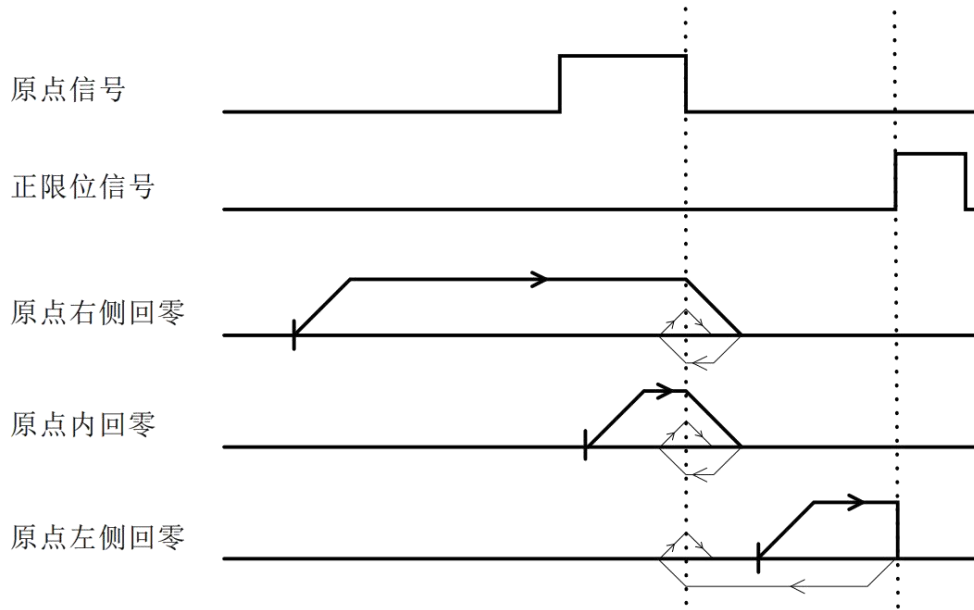

**5.3.15Way27(Origin + negative limit return to zero1)**

'Origin + negative limit return to zero1' The origin stop position is on the right side of the rising edge of the origin signal in the reverse direction.

'Origin + negative limit return to zero1' The whole action is the same as 'origin + positive limit return to zero1' The difference is that the initial running direction is opposite.

Please explain in more detail.

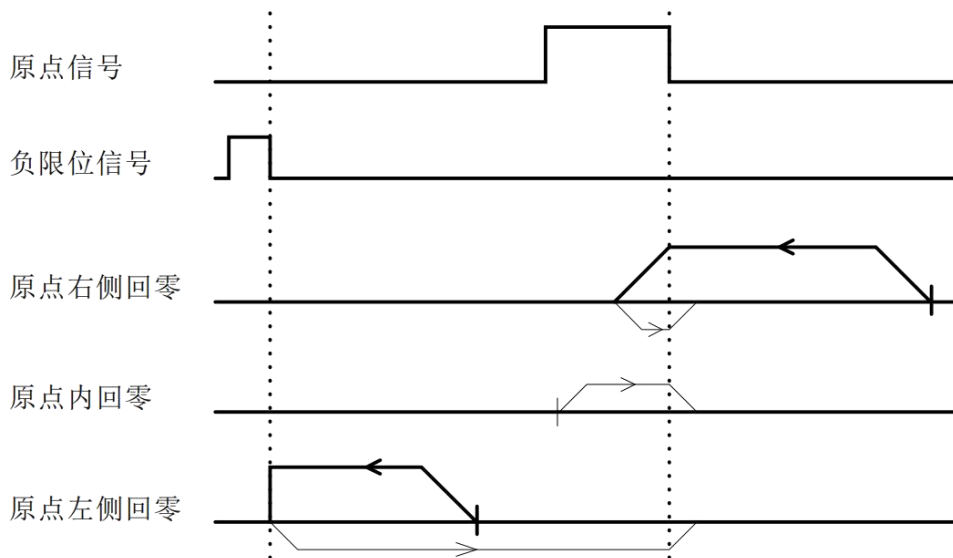

**5.3.16Way28(Origin + negative limit return to zero2)**

'Origin + negative limit return to zero2' The origin stop position is on the left side of the rising edge of the origin signal in the reverse direction.

'Origin + negative limit return to zero2' The whole action is the same as 'origin + positive limit return to zero2' The difference is that the initial running direction is opposite.

Please explain in more detail.

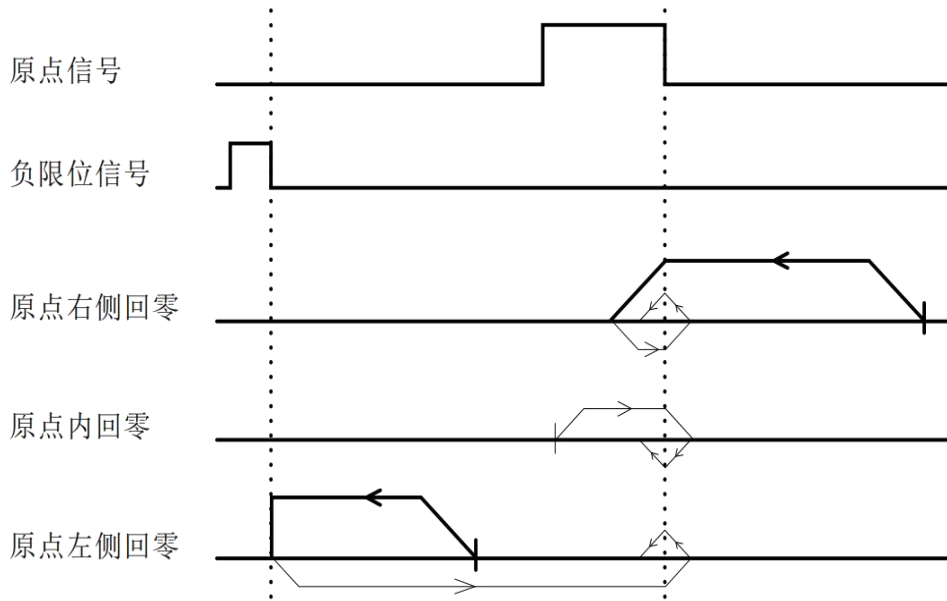

**5.3.17Way29(Origin + negative limit return to zero3)**

'Origin + negative limit return to zero3'The origin stop position is on the right side of the falling edge of the origin signal in the reverse direction.

'Origin + negative limit return to zero3'The whole action is the same as 'origin + positive limit return to zero3'The difference is that the initial running direction is opposite.

Please explain in more detail.

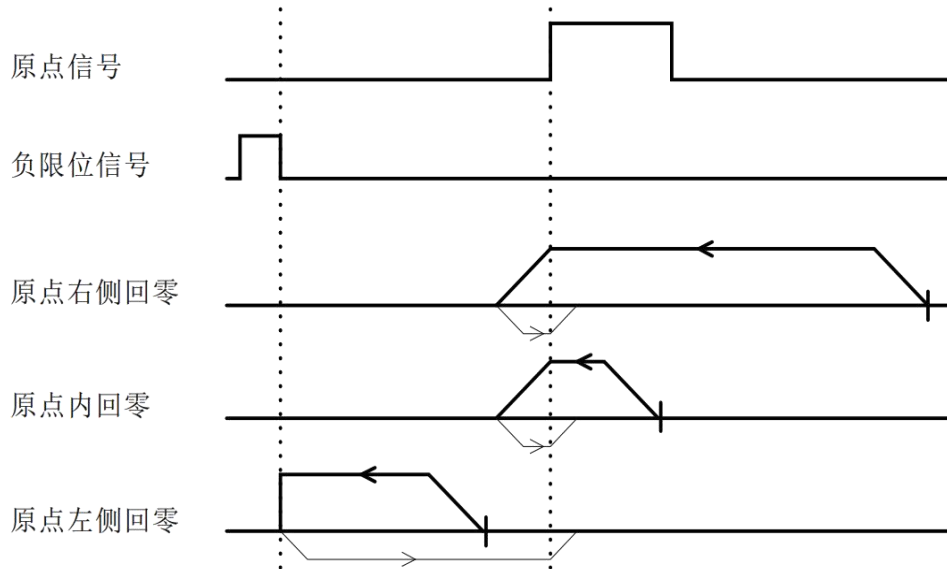

**5.3.18Way30(Origin + negative limit return to zero4)**

'Origin + negative limit return to zero4'The origin stop position is on the left side of the falling edge of the origin signal in the reverse direction.

'Origin + negative limit return to zero4'The whole action is the same as 'origin + positive limit return to zero4'The difference is that the initial running direction is opposite.

Please explain in more detail.

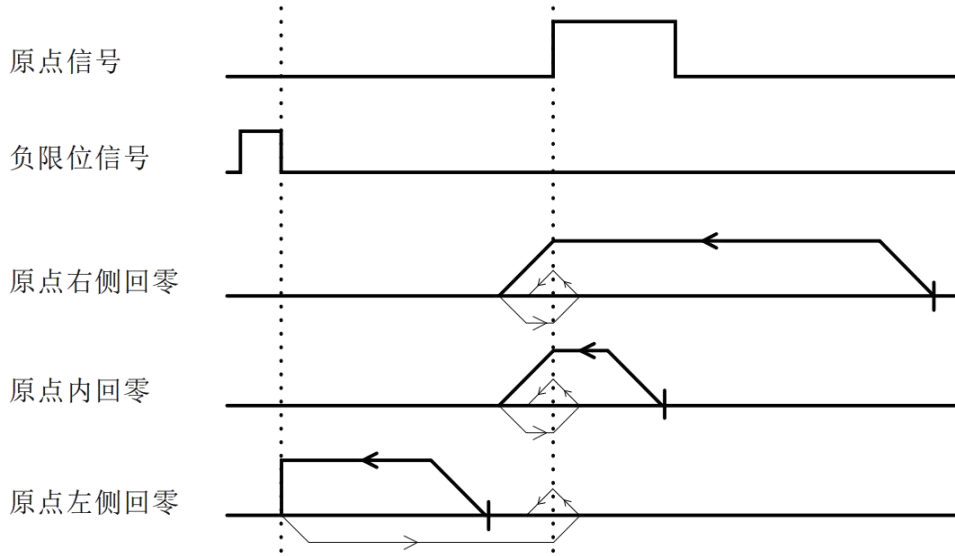

**5.3.19 Way33 (ZSignal return to zero1)**

This zero return method is ZThe signal is used as the zero return detection signal, which is consistent with the direction of 'negative limit zero return'. The origin stop position is ZSignal right.

'ZSignal return to zero1' The whole action is shown in the figure below. No detailed description is given here.

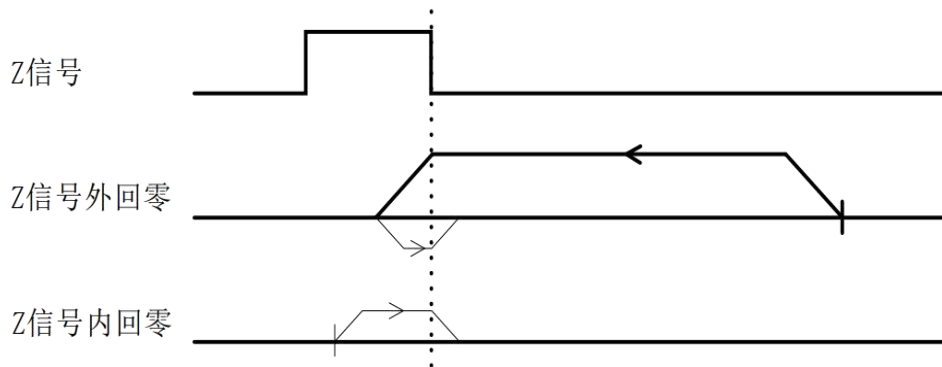

**5.3.20 Way34 (ZSignal return to zero2)**

This zero return method is ZThe signal is used as the zero return detection signal, which is consistent with the direction of 'positive limit return to zero'. The origin stop position is ZLeft side of signal.

'ZSignal return to zero2' The whole action is shown in the figure below. No detailed description is given here.

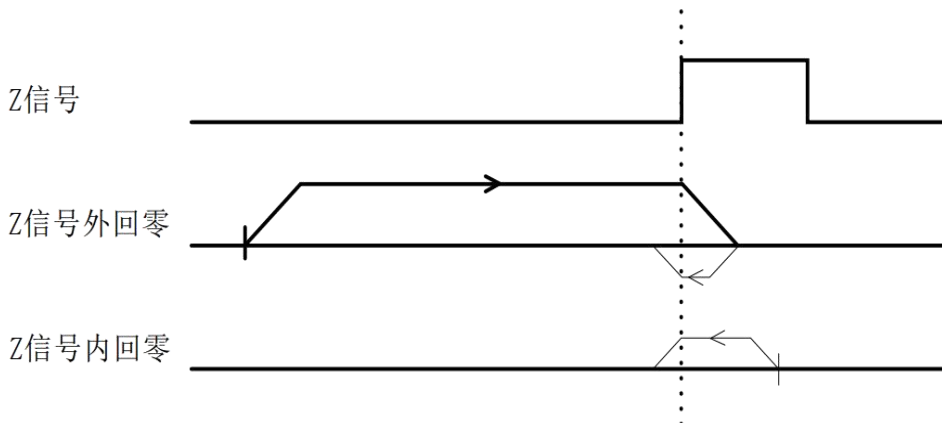

### **5.3.21Way35,37(The current position is the origin)**

This zero return method uses the current point as the origin.

### **5.3.22Way38(Position return mode1)**

This zero return method is consistent with the negative limit zero return direction. When the operation reaches the set position, it stops immediately and takes this position as the origin.

The position value is set by register0x0044,0x0045set up;

### **5.3.23Way39(Position return mode2)**

This zero return method is consistent with the positive limit zero return direction. When the operation reaches the set position, it stops immediately and takes this position as the origin.

The position value is set by register0x0044,0x0045set up;

**5.4 Multi-segment mode**

The multi-stage mode includes multi-stage position mode and multi-stage speed mode. The register range involved is:0x0060-0x015F.

**5.4.1 Multi-position mode**

The multi-segment position mode combines multiple position segments. According to its pathIONumber(PTIN0-PTIN3)And externalIOTrigger signal(TRIG,

You can also set the working mode to start the motor without this trigger signal to complete a series of position actions.

The multi-segment position mode function setting mainly uses two registers (path0As an example), as shown in the following table:

Register Name	Included Features
path0Function settings1	(1) Position/velocity mode; (2)Relative/absolute position selection; (3) IOIn-position output signal is prohibited; (4) Whether to jump; (5) Jump path number;
path0Function settings2	(1) Whether returning to the origin is enabled; (2) Whether to execute the path after returning to the origin; (3) Selection of parameters such as the speed of returning to the origin; (4) Return to origin method;

By configuring the function registers of the corresponding paths, various position mode controls can be realized, such asIOTrigger + PathIOModel,IOTrigger Order

Sub-cycle mode,IOTrigger continuous cycle mode, etc. Users can configure accordingly according to different needs. The following is a brief introduction to the three common modes.

**5.4.1.1 IOTrigger + PathIOModel**

IOTrigger + PathIOMode means that the execution of each location segment requires a pathIONumber(PTIN0-PTIN3)And externalIOTrigger signal

(TRIG)Start the motor and run. The execution diagram is shown below.

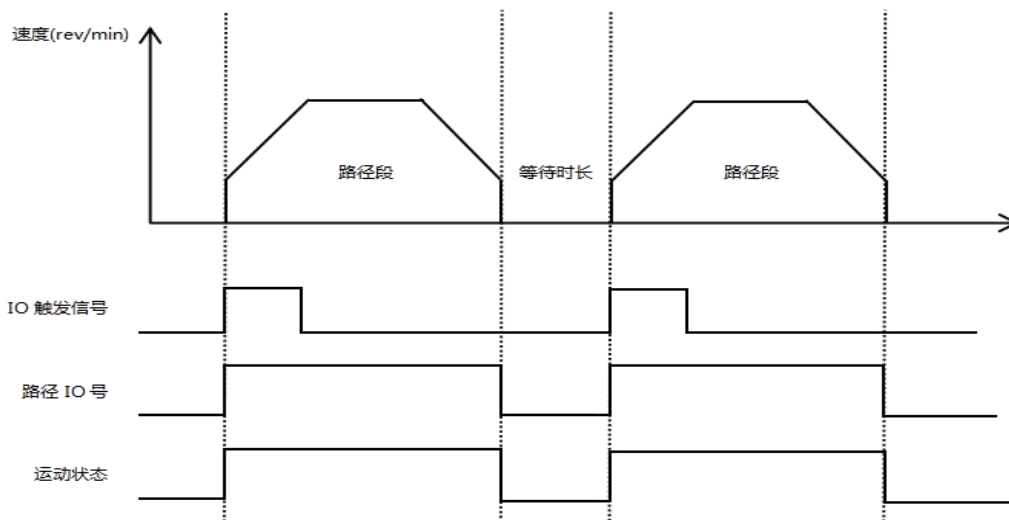

picture5.4 IOTrigger + PathIOMode operation diagram

**Note: This mode does not enable the path jump function, and the next path can only be given after the waiting time is over.IOTrigger signal!**

If you need to return to the origin before executing a certain path, you need to configure the register' path function setting2'function, turn on the return to origin enable bit, select return

The execution diagram includes parameters such as the speed of the origin, whether to execute the path after returning to the origin, and the corresponding return to the origin method, etc.

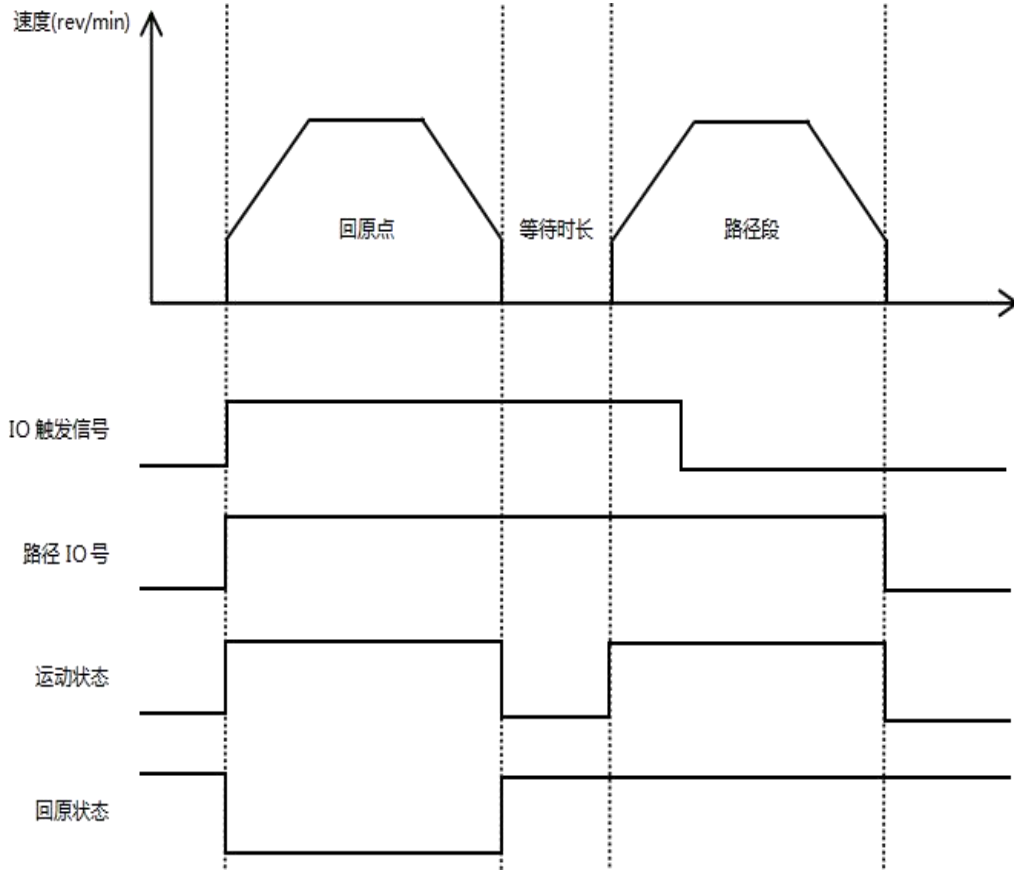

picture5.5Back to origin+IOTrigger + PathIOMode operation diagram

pathIOThe combination is currently available up to3individualIOBy settingIOIs the trigger function valid and can support startup4Segment or7Rank

The combinational logic is shown in the following table.

IOPort/Run	PTIN0	PTIN1	PINT2	pathIO	IOTrigger function	IOTrigger function
Path Segment				Combination Value	(TRIG)efficient	(TRIG)invalid
Path Segment0	0	0	0	0	1(Bootable)	-(invalid)
Path Segment1	1	0	0	1	1(Bootable)	-(bootable)
Path Segment2	0	1	0	2	1(Bootable)	-(bootable)
Path Segment3	1	1	0	3	1(Bootable)	-(bootable)
Path Segment4	0	0	1	4	-(invalid)	-(bootable)
Path Segment5	1	0	1	5	-(invalid)	-(bootable)
Path Segment6	0	1	1	6	-(invalid)	-(bootable)
Path Segment7	1	1	1	7	-(invalid)	-(bootable)



**5.4.1.2 IOTriggering single-shot mode**

IOTriggering the single loop mode means that each path starts the jump function (IOAfter the trigger function is valid, each time the externalIOTrigger signal(TRIG)

After the motor is started, it executes a full cycle. If you want to execute a second cycle, you need an externalIOTrigger signal(TRIG)Re-trigger

The execution diagram is shown below.

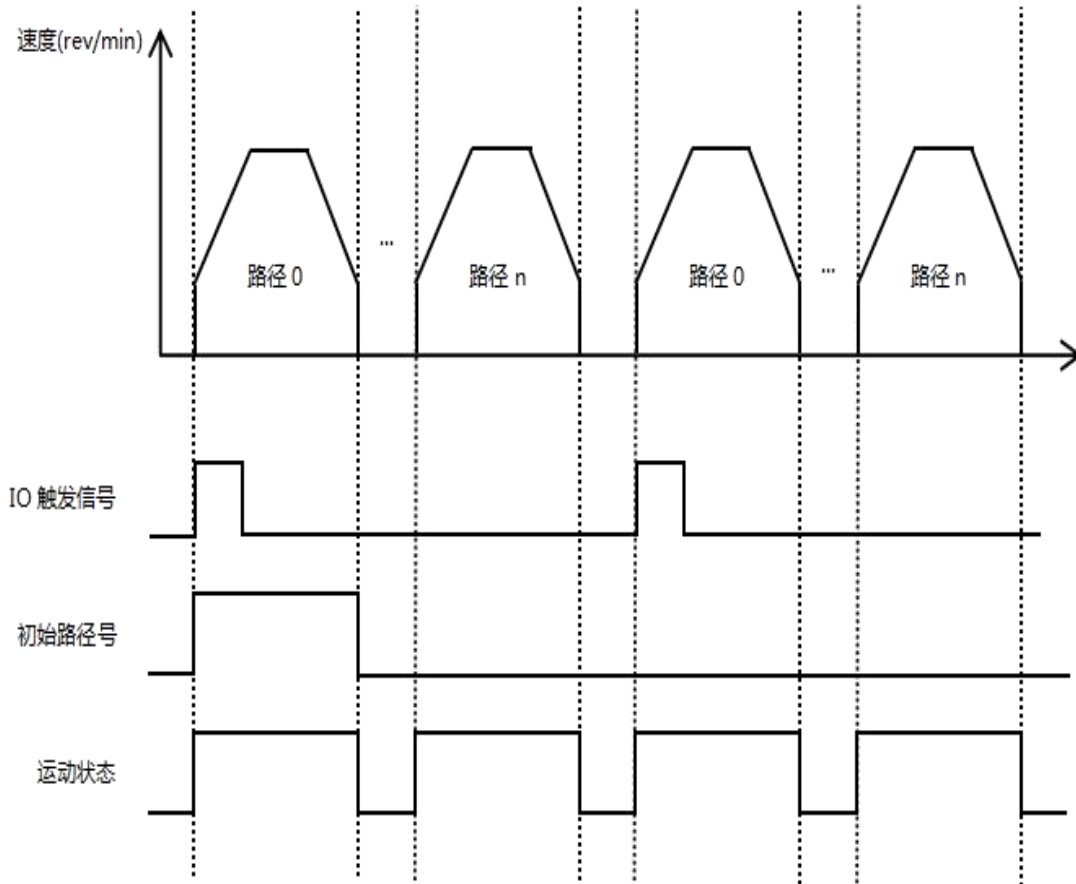

picture5.6 IODiagram of triggering single cycle mode operation

**Note: This mode requires the path jump function to be turned on, but the path jump function must be turned off for the last path segment!**

If you need to return to the origin before executing a certain path, you need to configure the register' path function setting2'function, turn on the return to origin enable bit, select return

The speed of the origin, whether to execute the path after returning to the origin, and the corresponding return to the origin method, etc. The execution trajectory of each path is shown in the figure.5.7

Similar, no further explanation here.

**5.4.1.3 IOTriggering continuous loop mode**

IOTriggering the continuous loop mode means that each path starts the jump function (IOAfter the trigger function is valid, when the externalIOTrigger signal(TRIG)start

After the motor is running, the preset position segment can be executed cyclically. The execution diagram is shown below.

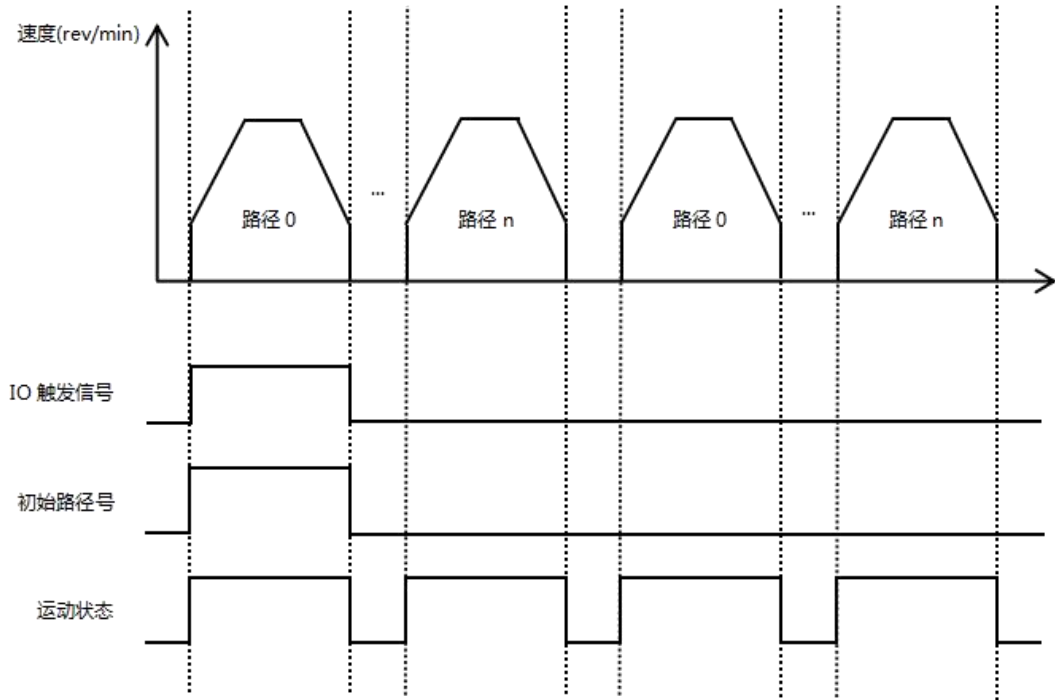

picture5.7 IO Diagram of triggering continuous loop mode operation

**Note: This mode requires the path jump function to be enabled, and the last path segmentThe jump path must be set to the initial path!**

If you need to return to the origin before executing a certain path, you need to configure the register' path function setting2'function, turn on the return to origin enable bit, select return

The speed of the origin, whether to execute the path after returning to the origin, and the corresponding return to the origin method, etc. The execution trajectory of each path is shown in the figure.5.7

Similar, no further explanation here.

### 5.4.2 Multi-speed mode

The multi-speed mode combines multiple speed sections. According to its pathIONumber(PTIN0~PTIN3)And externalIOTrigger signal(TRIG)

Start the motor to run and complete a series of speed operations.

The multi-speed mode function setting mainly uses two registers (path0As an example), as shown in the following table:

Register Name	Included Features
path0Function settings1	(1) Position/velocity mode; (2)Relative/absolute position selection; (3) IOIn-position output signal is prohibited; (4) Whether to jump; (5) Jump path number;
path0Function settings2	(1) Whether returning to the origin is enabled; (2) Whether to execute the path after returning to the origin; (3) Selection of parameters such as the speed of returning to the origin; (4) Return to origin method;

By configuring the function register of the corresponding path, the corresponding path can be configured to run in speed mode. Before executing speed mode operation,

First, execute the return to origin and other actions, but please note that the jump function is not supported in the multi-speed mode. The execution diagram is shown below.

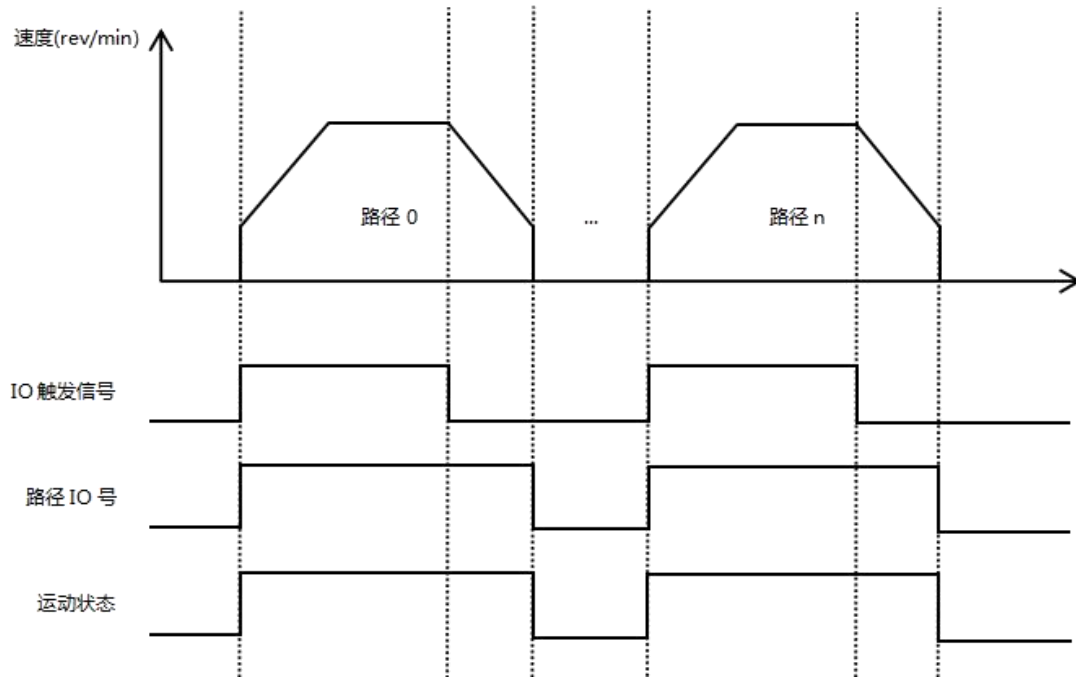

picture5.8 IOTrigger + PathIO Mode operation diagram

If you need to return to the origin first when executing a path at a certain speed, you need to configure the register' path function setting2'function, turn on the return to origin enable bit,

Select the parameters such as the speed of returning to the origin, whether to execute the path after returning to the origin, and the corresponding return to the origin method, etc. The execution trajectory of each path

Follow the picture5.7similar.

pathIOThe combination is currently available up to3individualIOBy settingIOIs the trigger function valid and can support startup4Segment or7Speed

The combinational logic is shown in the following table.

IOPort/Run Path Segment	PTIN0	PTIN1	PINT2	pathIO Combination Value	IOTrigger function (TRIG)efficient	IOTrigger function (TRIG)invalid
Path Segment0	0	0	0	0	1(Bootable)	-(invalid)
Path Segment1	1	0	0	1	1(Bootable)	-(bootable)
Path Segment2	0	1	0	2	1(Bootable)	-(bootable)
Path Segment3	1	1	0	3	1(Bootable)	-(bootable)
Path Segment4	0	0	1	4	-(invalid)	-(bootable)
Path Segment5	1	0	1	5	-(invalid)	-(bootable)
Path Segment6	0	1	1	6	-(invalid)	-(bootable)
Path Segment7	1	1	1	7	-(invalid)	-(bootable)

## 5.5 Motion control instructions

### 5.5.1 Startup Command

The start command address is 0x0037. Its functions include speed mode trigger, relative position mode trigger, absolute position mode trigger, and return to origin.

Mode trigger, each bit function definitions are shown in the following table:

register	Bit15	Bit14	Bit13	Bit12	Bit11	Bit10	Bit9	Bit8
0x0037 Startup Command	reserve	reserve	reserve	reserve	reserve	reserve	reserve	reserve
	Bit7	Bit6	Bit5	Bit4	Bit3	Bit2	Bit1	Bit0
	JOG- sports	JOG+ sports	Multi-speed trigger	Multi-segment position trigger	Back to origin trigger	Absolute Position trigger	Relative Position trigger	Speed Mode trigger

The following is an example of the settings:

Speed Mode Movement: 01 06 00 37 00 01 F9 C4

Relative position movement: 01 06 00 37 00 02 B9 C5

Absolute position movement: 01 06 00 37 00 04 39 C7

### 5.5.2 Stop Command

The stop command address is 0x0038. Its functions include normal stop, emergency stop, running at the set speed or running along the planned trajectory until

When the motor is running in position mode or speed mode, if it receives a normal stop command, the motor will decelerate and stop according to the set deceleration time.

If the stop command is sent, the system will stop the system directly. The setting value range is 0-2, the function definitions of each setting value are shown in the following table:

register	illustrate
0x0038 Stop Command	0: Normal stop; 1: Emergency stop; 2: Run at the set speed or along the planned trajectory until it stops;

The following is an example of the settings:

Normal stop: 01 06 00 38 00 01 C9 C7

Emergency Stop : 01 06 00 38 00 02 89 C6

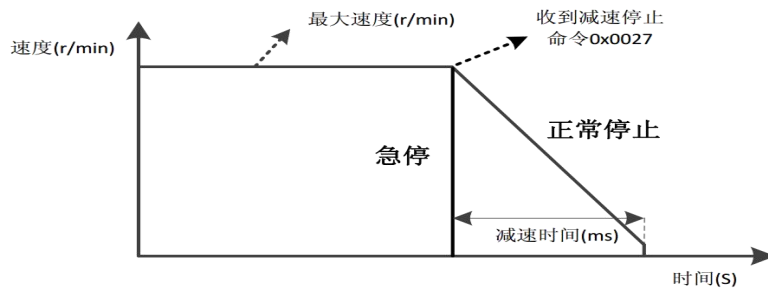

picture5.9 Normal stop and emergency stop

## 6. Indicator Light

### 6.1 Alarm fault code

IRS35(E) All-in-one 485 Bus type open (closed) loop stepper driver has a variety of alarm information. When the driver alarms, the fault code and processing

Measures as shown in the table 6.1. For details, please refer to the chapter 4.2.13 Related contents of fault code parameter group.

surface 6.1 Fault codes and solutions

Fault Codes	Fault subcode	Fault Information	Indicator Lights	Treatment measures
0x01	0x10;(reserve)	Overcurrent	Flash	(1)Check whether the motor wire is connected incorrectly; (2)Check whether there is contact between two adjacent wires; (3)After troubleshooting, power on again for testing;
0x02	0x20: Overpressure alarm; 0x21: Undervoltage alarm;	Overvoltage and undervoltage	Flash	Check the power supply
0x03	0x30: Positive hard limit overtravel; 0x31: Reverse hard limit overtravel; 0x32: Forward soft limit overtravel; 0x33: Reverse soft limit overtravel;	Hard limit/soft Limit overtravel	none	Move in the opposite direction;
0x04	0x41: Read error; 0x42: Write error;	EEPROM Read and write errors	none	Resettable
0x05	0x51: CRC Verification error; 0x52: Function code error; 0x53: Error in reading illegal data address; 0x54: The write data address is out of range; 0x55: Read register number overflow (maximum one Read 16 registers); 0x56: Illegal reading and writing of function code; 0x57: The data written into the register exceeds the limit;	MODBUS Communication Error	none	Resettable
0x06	0x60:A,B,ALL lack phase alarm; 0x61:Aphase lacks phase; 0x62:Bphase lacks phase;	Phase loss alarm	Flash	(1)Check whether the motor wiring is loose or connected incorrectly; (2)After troubleshooting, power on again for testing;
0x07	0x70: Normal out-of-tolerance alarm; 0x71: Overvoltage causes out-of-tolerance alarm; 0x72: Undervoltage causes out-of-tolerance alarm;	Out of tolerance alarm	Flash	(1)Check whether the motor wiring is correct; (2)Check whether the current setting is sufficient; (3)Check whether the power supply is sufficient; (4)The alarm can be cleared by enabling the signal;
0x08	0x80: Timeout alarm when returning to origin;	Back to origin Timeout alarm	Flash	(1)Check whether the limiter is damaged; (2)Check whether the limit wiring is loose; (3)Can be controlled by host computer or external I/O input power This alarm can be cleared;
0x09	0x90: Restore factory settings;	Factory Reset/	Flash	(1) Wait for the indicator light to stop flashing and return to normal

	<p>0x91: Save the status parameter group;</p> <p>0x92: Save the common parameter group;</p> <p>0x93: Save the common open-loop parameter group;</p> <p>0x94: Save the common closed-loop parameter group;</p> <p>0x95: Save the basic control parameter group;</p> <p>0x96: Save the back-to-origin parameter group;</p> <p>0x97: Save the input and output parameter groups;</p> <p>0x98: Save multi-segment mode parameter group;</p> <p>0x99: Save the performance parameter group;</p> <p>0x9A: Save the brake parameter group;</p> <p>0x9B: Save fault code parameter group;</p> <p>0x9C: Save user parameter group;</p> <p>0x9D~0x9E:reserve;</p> <p>0x9F: Save all parameter groups;</p>	<p>Save Parameters</p>		<p>The status will be displayed before the next operation can be performed;</p>
0x0A	<p>0xA0:Vmax&gt;Vmin;</p>	<p>Speed Parameters</p> <p>Inappropriate settings</p> <p>Alarm</p>	<p>none</p>	<p>Check if the maximum speed value is less than the minimum speed value;</p>

## 6.2 Flashing lights

IRS35(E) All-in-one 485 Bus type open (closed) loop stepper driver has a green LED light and a red LED light, one can be used as a power indicator

The first indicator light can be used as a fault indicator light, the second indicator light can be used as a DIP switch indicator light, and the indicator light for saving or restoring parameters. The specific relationship is as follows: 6.2As shown:

When the drive is powered on, the green LED light is on. When the drive is powered off, the red LED light is off.







When the DIP switch is turned, the green LED light will flash quickly. This is a normal phenomenon, indicating that the DIP switch status is effective.

When the drive fails, the red and green lights flash alternately, and different flashing patterns indicate different fault information.

When eliminated, the green LED light keeps on, and the red LED light is off.

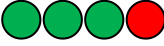
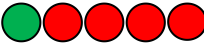
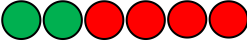
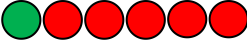
When saving/restoring parameters, the red and green lights flash alternately. When saving/restoring parameters is completed, the green LED light is steady on, and the red LED light is off.

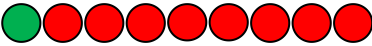
Table 6.2 LED Status Indicator

Number of flashes		Phenomenon	Illustrate
green LED	red LED	After the green light flashes, the red light flashes	
0	-	Green light is always on, red light is off	Driver Enable
1	-	Green light flashes, red light off	The driver is enabled and receives a pulse or start command
1	1		Normal out-of-tolerance alarm
2	1		The drive is not enabled and receives a pulse or start command
3	1		(Overvoltage) out-of-tolerance alarm
4	1		(Undervoltage) out-of-tolerance alarm
1	4		Overpressure alarm
2	4		Undervoltage alarm
1	5		Overcurrent alarm (reserved)
1	6		AB Phase loss alarm
2	6		only A Phase loss alarm
3	6		only B Phase loss alarm
1	8		Timeout alarm in homing mode
1	2		Restoring parameters
2	2		Saving parameters in progress

7. Adaptive motor parameters and selection

7.1 Motor appearance diagram

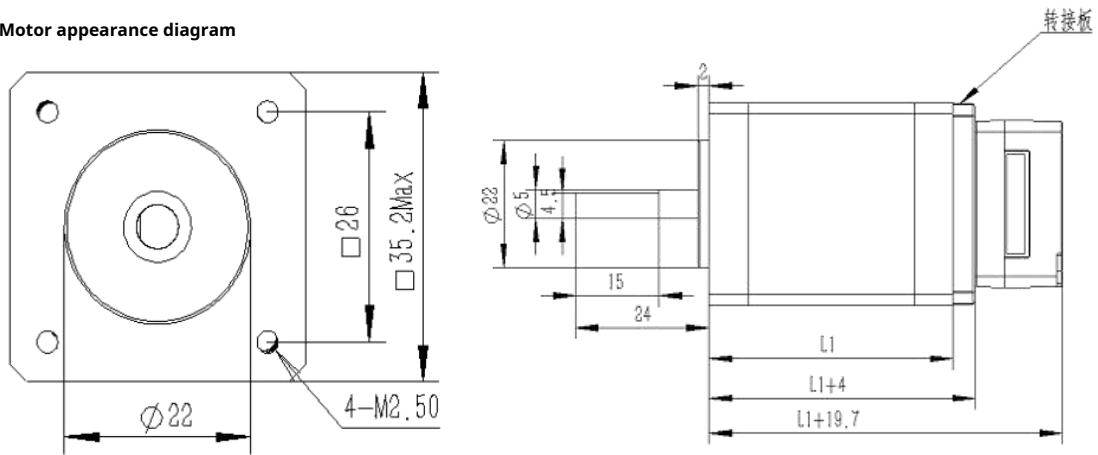

picture6.1 IRS35(E)Schematic diagram of the appearance of the series of integrated machines

7.2 Motor technical parameters

model	Keep	Phase current (A)	resistance ( $\Omega$ )	inductance (MH)	Rotation Inertia(g.cm <sup>2</sup> )	Motor	Adapter Plate (mm)	Tail cover length (mm)	weight (Kg)	Line number
	Torque (mN.M)					lengthL1 (mm)				
IRS35M-36	220	1.5	1.00	1.0	31	36Max.	4	15.7	0.21	4
IRS35M-56	400	1.5	1.40	1.5	62	56Max.	4	15.7	0.35	4
IRS35EM-36	220	1.5	1.00	1.0	31	36Max.	4	15.7	0.21	4
IRS35EM-56	400	1.5	1.40	1.5	62	56Max.	4	15.7	0.35	4

7.3 Motor shaft parameters

model	Shaft diameter(mm)	Shaft extension(mm)	Flat position(mm)	Boss(mm)
IRS35M-36	5.0	twenty four	4.5*15	2*22
IRS35M-56	5.0	twenty four	4.5*15	2*22
IRS35EM-36	5.0	twenty four	4.5*15	2*22
IRS35EM-56	5.0	twenty four	4.5*15	2*22



7.4Wiring Definition

型号: XH01-12PS-M30-TZ006  
 28/35一体机标准线 (GH-1.25mm\*12pin) 线长300mm线芯0.14平方

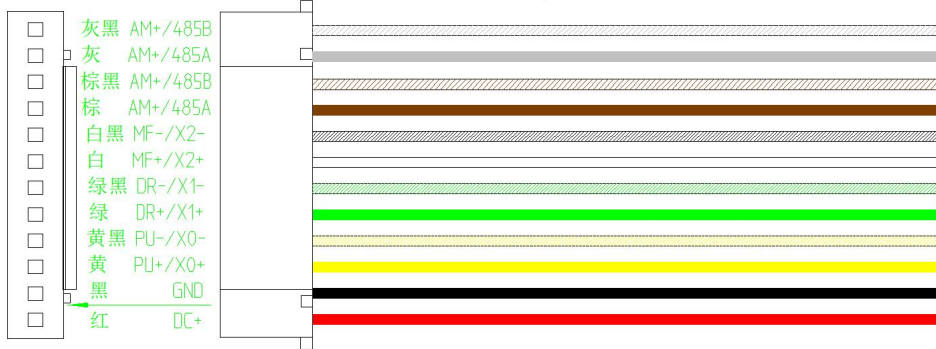

picture6.2 IRS35(E)Series wiring diagram

## 8. Warranty and after-sales service

### 8.1 Warranty

#### 8.1.1 Free warranty situation

Our company solemnly promises that if any of our products are damaged during use due to the product itself, we will provide

One year free maintenance service. The shipping cost of the product shall be borne by both parties.

#### 8.1.2 Warranty void

- (1) The driver is damaged due to the customer's own wiring error;
- (2) Exceeding the rated working voltage causes damage to the driver;
- (3) The DC power supply driver is connected to the AC power supply, causing the driver to be damaged;
- (4) Due to the extremely bad environment on the customer's site, such as humidity, extreme cold, extreme heat and other adverse environmental factors, the company was not informed in advance, resulting in

The drive is damaged;

- (5) The customer dismantles the drive housing without permission or the serial label number is torn off;
- (6) After the customer confirms receipt 15 Days later, the casing was obviously damaged or hit, causing damage to the drive;
- (7) Force majeure natural disasters, such as fire, earthquake, tsunami, typhoon, etc.;

In the above cases, our company will charge a certain amount of repair cost after evaluating the interests of all parties. In other cases, repairs will be provided free of charge forever.

### 8.2 Exchange

#### 8.2.1 Product defect replacement

For faults in new products, our company provides three months of free replacement service.

After our technical support staff confirms that the problem is with the product itself, they will send the product back to our company to avoid wasting time and postage on the round-trip.

The customer needs to send the defective product back by express or logistics first. After receiving it, our company will send another new product back to the customer as soon as possible.

**Notice:** All our products are strictly tested and aged before leaving the warehouse, so it is extremely rare for new products to fail.

Please be sure to read the instructions carefully or consult our technical support staff when operating, or our technical support staff will assist customers in operating remotely.

— Please note the following points when exchanging goods:

- (1) Please ensure that the packaging is complete when sending back to avoid damage during transportation;
- (2) Please ensure that the attached accessories are complete when exchanging goods;
- (3) Each driver should be packed in its original box to avoid secondary damage to the product during transportation;

(4) If the driver is returned and it is confirmed that the fault is not due to product failure, but due to the customer's negligence in operation, then

The company does not bear the freight (the customer's own negligence includes: connecting the wrong line and causing the driver to be damaged, poor wiring and mistaking the driver for damage,

Operation errors causing the drive to fail to function properly, etc.).

### **8.2.Exchange for non-product failure**

If the customer is not satisfied with the appearance or function of the product received and wants to replace it with a better driver, he or she can contact us within one week after receiving the product.

The company applies for a replacement service. After verification, the company will return the product. The company will confirm that the returned product has no damage, complete accessories, and

If the product is in good condition, we will replace it with another product. If there is a price difference between the replaced products, the customer shall make up the difference.

**Note: The replaced product will no longer be eligible for the non-product failure replacement service. The round-trip shipping and other fees incurred by the non-product failure replacement service**

**All costs are borne by the customer!**

### **8.3.return the goods**

Our company provides 7 Days return service, if you receive this product 7 Days (subject to the actual receipt date of the customer)

If there are any quality problems with the product itself, please communicate with our salesperson or technical support personnel in time.

After the quality problem of the product itself is found, the customer will send the original complete product and its inner and outer packaging, accessories and shipping order back to our company by express or logistics.

If the customer still insists on returning the goods after our company has checked and confirmed that they are correct, the round-trip shipping costs and all other costs incurred will be borne by the customer.

At your own risk.

- Please note the following points when returning goods:

- (1) Please contact the relevant department of our company before making a refund;
- (2) The product must be in new condition and complete packaging. Please send it back to our company by express or logistics;
- (3) Problems caused by customers such as damaged product appearance, incomplete accessories, etc. will not be accepted;

### **8.4.After-sales service**

If you need after-sales service support when using this product, please contact our company as soon as possible.

National free service hotline:0755-23206995;

Technical specialist service hotline:18576758897(Mr. Xie),17666115681(Mr. Tuo);

Service time: Monday to Friday8:30-17:30(Except national holidays).

**IX. Version Revision History**

Version Number	illustrate	Modify deadline	Preparer/Reviewer
V1.0.0	Initial use version;	2024.06.28	TCJ/XH